

**BARCO** VISION  
8200

R9001280

**OWNER'S MANUAL**



# BARCO

BARCO PROJECTION SYSTEMS

**BARCO** VISION  
8200

R9001280

**OWNER'S MANUAL**

Date :  
280497

Rev :  
01

Art. No. :  
R5975348

Due to constant research, the information in this manual is subject to change without notice.

Produced by BARCO NV, April 1997.  
All rights reserved.

Trademarks are the rights of their respective owners.

Printed in Belgium

**BARCO nv/Projection Systems**

Noordlaan 5  
B-8520 Kurne  
Belgium

Printed in Belgium

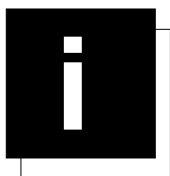

# TABLE OF CONTENTS

TABLE OF CONTENTS .....	i-1
SAFETY INSTRUCTIONS .....	1-1
REMARQUE SUR LA SÉCURITÉ .....	1-2
UNPACKING AND DIMENSIONS .....	2-1
Unpacking .....	2-1
Projector dimensions .....	2-1
Battery installation in the RCU. ....	2-2
INSTALLATION GUIDELINES .....	3-1
Environment .....	3-1
What about ambient light ? .....	3-1
Which screen type? .....	3-1
What image size? How big should the image be? .....	3-1
Where to install the projector? .....	3-2
How to install a projection lens? .....	3-3
How to install the projector? .....	3-3
LOCATION AND FUNCTIONS OF CONTROL .....	4-1
Front panel terminology .....	4-1
Control panel terminology .....	4-1
INSTALLATION SET UP .....	5-1
CONNECTIONS .....	6-1
Power (mains) cord connection .....	6-1
Fuses .....	6-1
Switching on .....	6-1
Switching to stand-by. ....	6-2
Switching off .....	6-2
Input connections. ....	6-2
Input module insertion into the projector .....	6-2
Video/S-video input module .....	6-3
RGB analog input module. ....	6-4
Component input module. ....	6-5
RGB3S/RG3sB input module. ....	6-6
Connecting a computer, e.g. IBM PC (or compatible), Apple Macintosh to the RS 232 input of the projector .....	6-7
Set up of the baud rate for communication with a computer. ....	6-7
Connecting a RCVDS 05 to the projector. ....	6-8
Connecting a VS05 to the projector .....	6-8
Connecting an IR Remote Receiver 800 to the projector. ....	6-8
CONTROLLING .....	7-1
How to use the RCU? .....	7-1
Projector address .....	7-1
How to display a projector address? .....	7-2
How to program an address into the RCU? .....	7-2
Picture controls with direct access. ....	7-2
How to get source information .....	7-3
How to get a summary of your projector .....	7-4
SOURCE SET UP .....	8-1
Input selection .....	8-1
Installation of the settings for a input source .....	8-1
Edit file .....	8-2
Rename .....	8-4
Copy .....	8-4
Move .....	8-5
Delete .....	8-5
Options .....	8-5
PICTURE CONTROL IN ADJUSTMENT MODE .....	9-1
Signal operations .....	9-1
Video offset .....	9-1
Gain .....	9-1

Table of Contents

---

Gain adjustment per color .....	9-2
Smoothness .....	9-2
Still Video .....	9-2
Sync .....	9-2
Color balance .....	9-2
Screen operations .....	9-3
Zoom/pan .....	9-3
Configure .....	9-7
Conversion .....	9-7
Geometry .....	9-7
<b>SERVICE MODE .....</b>	<b>10-1</b>
How to activate the password function .....	10-1
Start up the Service mode .....	10-1
Convergence adjustment of the LCD panels .....	10-2
Modify password .....	10-5
Lamp run time history .....	10-5
Reset lamp run time .....	10-5
Appendix A : Standard Source Set Up Files .....	A-1
Appendix B : Battery replacement in the RCU .....	B-1
Appendix C : Lenses .....	B-1
Focusing the lens .....	B-1
Lens Cleaning Procedure .....	B-1
Lenses .....	B-2
Appendix D : Source numbers 90 - 99 .....	C-1

# 1

## SAFETY INSTRUCTIONS

Projectors are built in accordance with the requirements of the international safety standards IEC950, UL 1950 and CSA C22.2 No. 950, which are the safety standards of information technology equipment including electrical business equipment.

These safety standards impose important requirements on the use of safety critical components, materials and isolation, in order to protect the user or operator against the risk of electric shock and energy hazard, and having access to live parts.

Safety standards also impose to the internal and external temperature rises, radiation levels, mechanical stability and strength, enclosure construction and protection against risk of fire.

Simulated single fault condition testing ensures the safety of the equipment to the user even when the equipment's normal operation fails.

### Installation instructions

Before operating your projector please read this manual thoroughly, and retain it for future reference.

Installation and preliminary adjustments should be performed by qualified BARCO personnel or authorized BARCO service dealers.

### OWNER'S RECORD

The part number and serial number are located at the front of the projector. Record these numbers in the spaces provided below. Refer to them whenever you call upon your BARCO dealer regarding this product.

**PART NUMBER:**

**SER. NUMBER:**

**DEALER:**

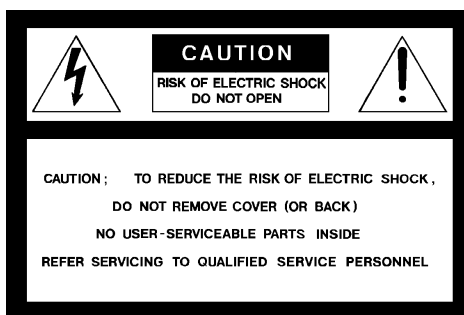

The lightning flash with an arrowhead within a triangle is intended to tell the user that parts inside this product are risk of electrical shock to persons.



The exclamation point within a triangle is intended to tell the user that important operating and/or servicing instructions are included in the technical documentation for this equipment.

**Warning**  
**To prevent fire or electrical shock hazard, do not expose this projector to rain or moisture**

### Federal communication commission (FCC statement)

This equipment has been tested and found to comply with the limits for a class A digital device, pursuant to Part 15 of the FCC Rules. These limits are designed to provide reasonable protection against harmful interference when the equipment is operated in a commercial environment. This equipment generates, uses, and can radiate radio frequency energy and, if not installed and used in accordance with the instruction manual, may cause harmful interference to radio communications. Operation of this equipment in a residential area is likely to cause harmful interference in which case the user will be required to correct the interference at his own expense.

Instructions to the user :

if this equipment does cause interference to radio or television reception, the user may try to correct the interference by one or more of the following measures :

- Re-orientation of the receiving antenna for the radio or television.
- Relocate the equipment with respect to the receiver.
- Plug the equipment into a different outlet so that the equipment and receiver are on different branch circuits.
- Fasten cables connectors to the equipment by mounting screws.

Note :

*The use of shielded cables is required to comply within the limits of Part15 of FCC rules and EN55022.*

### General safety instructions.

- \* All the safety and operating instructions should be read before using this unit.
- \* The operating instructions manual should be retained for future reference.
- \* All warnings on the projector and in the documentation manuals should be adhered to.
- \* All instructions for operating and use of this equipment must be followed precisely.

### ON SAFETY

- \* This product should be operated from an AC power source. This projector may be connected to an IT-power system.
- \* This product is equipped with a 3-wire grounding plug, a plug having a third (grounding) pin. This plug will only fit into a grounding-type power outlet. This is a safety feature. If you are unable to insert the plug into the outlet, contact your electrician to replace your obsolete outlet. Do not defeat the purpose of the grounding-type plug.

**WARNING FOR THE CUSTOMERS:** THIS APPARATUS MUST BE GROUNDED (EARTHED) via the supplied 3 conductor AC power cable.  
 (If the supplied power cable is not the correct one, consult your dealer.)

### Mains lead (AC Power cord) with CEE 7 plug:

The colors of the mains lead are colored in accordance with the following code:

- |                   |                      |
|-------------------|----------------------|
| Green-and-yellow: | Earth (safety earth) |
| Blue:             | Neutral              |
| Brown:            | Line                 |

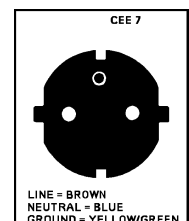

## Remarque sur la Sécurité

Les projecteurs sont fabriqués conformément aux exigences des normes de sécurité internationales IEC950, UL 1950 et CSA C22.2 No. 950. Ces normes de sécurité sont imposées aux équipements de la technologie informatique incluant les équipements électriques.

Ces normes de sécurité imposent des exigences importantes sur l'emploi des composants, des matériaux et de l'isolation dont la sécurité est critique, afin de protéger l'utilisateur contre le risque d'une décharge électrique et d'avoir accès aux parties sous tension.

Les normes de sécurité aussi imposent des limitations concernant la hausse de la température interne et externe, les niveaux de radiation, la stabilité et la force mécanique, la construction du cadre métallique à l'intérieure et la protection contre les risques d'incendie.

Les épreuves auxquelles l'équipement a été subi assurent la sécurité totale de l'utilisateur, même lorsque l'équipement ne fonctionne pas normalement.

## Instructions pour l'installation

Lire ce manuel complètement avant de mettre l'appareil en fonctionnement et le conserver pour consultation ultérieure.

L'installation et les réglages préliminaires devraient être faits par du personnel qualifié BARCO ou par des agents autorisés du service BARCO.

### DONNEES POUR LE PROPRIETAIRE

Le numéro de pièce et le numéro de série sont situés à l'arrière du projecteur. Copier ces numéros dans les espaces prévus ci-dessous. Se référer à ces numéros chaque fois que vous consultez votre agent BARCO concernant cet appareil.

**NUMERO DE PIECE :**

**NUMERO DE SERIE :**

**AGENT :**

Si vous trouvez cet autocollant sur le projecteur ou sur une partie intérieure du projecteur, l'ouvrage ne peut être effectué que par du personnel qualifié.



L'éclair avec une tête de flèche dans un triangle indique à l'utilisateur que les pièces à l'intérieur de l'appareil présentent un risque de chocs électriques.



Le point d'exclamation dans un triangle indique à l'utilisateur que des instructions de fonctionnement et/ou de service sont comprises dans la documentation technique de cet équipement.

**AVERTISSEMENT**  
**POUR EVITER DES RISQUES D'INCENDIE OU DE CHOCS ELECTRIQUES, NE PAS EXPOSER CE PROJECTEUR A LA PLUIE OU A L'HUMIDITE**

## Fédéral communication commission (FCC statement)

Cet équipement a été testé et trouvé conforme aux limites imposées aux appareils digitaux de classe A, selon la section 15 des règles FCC. Ces limites sont conçues pour fournir une protection raisonnable contre les interférences lorsque l'utilisation doit se faire dans un environnement commercial. Cet équipement génère, utilise et peut émettre de l'énergie aux fréquences radio, et s'il n'est pas installé et utilisé conformément aux instructions du manuel, il peut créer des interférences désavantageuses dans les communications radio. L'utilisation de cet équipement dans des zones résidentielles peut créer des interférences. Le cas échéant, l'utilisateur devra prendre toutes les mesures requises pour les amoindrir, à ses propres frais. Instructions pour l'utilisateur :

Si cet équipement cause des interférences de radio ou de télévision, l'utilisateur peut essayer de corriger les interférences en appliquant une ou plusieurs des mesures suivantes :

- Ré-orienter l'antenne radio ou télévision.
- Déplacer l'équipement concernant le récepteur.
- Brancher l'appareil sur une autre prise de telle sorte que l'appareil et le récepteur se trouvent sur différents circuits électriques.
- Fixer les connecteurs des cables à l'équipement au moyen des vis.

Remarque :

L'utilisation de câbles blindés est exigée afin d'observer les règles de la section 15 des règles FCC et EN55022.

## Prescriptions de securite générales.

- \* Lire toutes les prescriptions de sécurité et de fonctionnement avant d'utiliser cet appareil.
- \* Le manuel de prescriptions de securite et de fonctionnement doit être conservé pour consultation ultérieure.
- \* Il faut respecter tous les avertissements mentionnés sur le projecteur et dans les manuels.
- \* Suivre fidèlement toutes les prescriptions d'utilisation et de fonctionnement de cet équipement.

## SECURITE

\* Cet équipement doit fonctionner sur une source à courant alternatif. Ce projecteur peut être branché sur un système à IT courant.

\* Cet appareil est équipé d'un connecteur à trois broches dont une mise à la terre. Le connecteur n'est adapté qu'à des prises de courant du type avec terre. Ceci est une mesure de sécurité. Si le connecteur ne s'adapte pas dans la prise, contacter votre électricien pour remplacer la prise non valable. Ne pas compromettre le but du connecteur de terre.

Avertissement pour les utilisateurs : CE PROJECTEUR DOIT ÊTRE MIS À LA TERRE avec le cordon secteur fourni.

(Si le cordon secteur n'est pas correct, consulter votre revendeur.)

### Cordon d'alimentation avec connecteur CEE7

Les couleurs des fils du cordon d'alimentation sont codées comme suit :

- Vert et jaune : terre
- Bleu : neutre
- Brun : sous tension (actif)

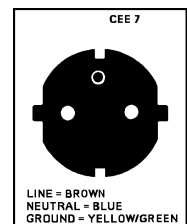



- \* Do not allow anything to rest on the power cord. Do not locate this product where persons will walk on the cord.
- \* To disconnect the cord, pull it out by the plug. Never pull the cord itself.
- \* If an extension cord is used with this product, make sure that the total of the ampere ratings on the products plugged into the extension cord does not exceed the extension cord ampere rating. Also make sure that the total of all products plugged into the wall outlet does not exceed 15 amperes.
- \* Never push objects of any kind into this product through cabinet slots as they may touch dangerous voltage points or short out parts that could result in a risk of fire or electrical shock.
- \* Never spill liquid of any kind on the product. Should any liquid or solid object fall into the cabinet, unplug the set and have it checked by qualified service personnel before resuming operations.
- \* Lightning - For added protection for this video product during a lightning storm, or when it is left unattended and unused for long periods of time, unplug it from the wall outlet. This will prevent damage to the projector due to lightning and AC power-line surges.
- \* To reduce the lamp heat of the projector, switch the projector **first** to stand-by and let the projector lamp cool down for at least 15 minutes. Then the projector may be switched off with the power switch.

### On Installation

- \* Do not place this projector on an unstable cart, stand, or table. The projector may fall, causing serious damage to it.
- \* Do not use this projector near water.
- \* Use only the power cord supplied with your projector. While appearing to be similar, other power cords have not been safety tested at the factory and may not be used to power the projector. For a replacement power cord, contact your dealer.
- \* Slots and openings in the cabinet and the sides are provided for ventilation; to ensure reliable operation of the projector and to protect it from overheating, these openings must not be blocked or covered. The openings should never be blocked by placing the product on a bed, sofa, rug, or other similar surface. This product should never be placed near or over a radiator or heat register. This projector should not be placed in a built-in installation or enclosure unless proper ventilation is provided.
- \* Do not block the projector cooling fans or free air movement under and around the projector. Loose papers or other objects may not be nearer to the projector than 4" on any side.

### On Servicing

Do not attempt to service this projector yourself, as opening or removing covers may expose you to dangerous voltage potential and risk of electric shock! Refer all projector service to a qualified BARCO service center.

Call for service in the following conditions :

- When the power cord or plug is damaged or frayed.
- If liquid has been spilled into the projector.
- If the product has been exposed to rain or water.
- If the product does not operate normally when the operating instructions are followed.  
Adjust only those controls that are covered by the operating instructions since improper adjustment of the other controls may result in damage and will often require extensive work by a qualified technician to restore the product to normal operation;

- If the product has been dropped or the cabinet has been damaged;
- If the product exhibits a distinct change in performance, indicating a need for service.

**Replacement parts** - When replacement parts are required, be sure the service technician has used original BARCO replacement parts or authorized replacement parts which have the same characteristics as the BARCO original part. Unauthorized substitutions may result in degraded performance and reliability, fire, electric shock or other hazards. Unauthorized substitutions may void warranty.

**Safety check** - Upon completion of any service or repairs to this projector, ask the service technician to perform safety checks to determine that the projector is in proper operating condition.

The projector uses a 1500 W metal halide projection lamp. Replacing the projection lamp with any other projection lamp can cause overheating or unacceptable image quality. Use only the projection lamps specified by BARCO, or an authorized BARCO dealer or service center.

### On Cleaning

Unplug this product from the wall outlet before cleaning. Do not use liquid cleaners or aerosol cleaners. Use a damp cloth for cleaning.

To keep the cabinet looking brand-new, periodically clean it with a soft cloth. Stubborn stains may be removed with a cloth lightly dampened with mild detergent solution. Never use strong solvents, such as thinner or benzene, or abrasive cleaners, since these will damage the cabinet.

To ensure the highest optical performance and resolution, the projection lenses are specially treated with an anti-reflective coating, therefore : avoid touching the lens. To remove dust on the lens, use a soft dry cloth. Do not use a damp cloth, detergent solution, or thinner. Follow the lens cleaning procedure on Appendix B in the Owners Manual.

### On Repacking

Save the original shipping carton and packing material; they will come in handy if you ever have to ship your projector. For maximum protection, repack your set as it was originally packed at the factory.

### On illumination

In order to obtain the best quality for the projected image, it is essential that the ambient light which is allowed to fall on the screen be kept to an absolute minimum.

When installing the projector and screen, care must be taken to avoid exposure to ambient light directly on the screen. Avoid adverse illumination on the screen from direct sunlight or fluorescent lighting fixtures.

The use of controlled ambient lighting, such as incandescent spot light or a dimmer, is recommended for proper room illumination. Where possible, care should also be taken to ensure that the floors and walls of the room in which the projector is to be installed are non-reflecting, dark surfaces. Brighter surfaces will tend to reflect and diffuse the ambient light and hence reduce the contrast of the projected image on the screen.

- \* Ne rien laisser en appui sur le cordon d'alimentation. Ne pas placer ce cordon là où des personnes risquent de marcher dessus.
- \* Pour débrancher le cordon, le tirer par le connecteur, jamais par le cordon lui-même.
- \* Si on utilise une rallonge, vérifier que le total des courants des appareils raccordés à cette rallonge ne dépasse pas la capacité nominale du câble de rallonge. Vérifier aussi que la somme des consommations des appareils raccordés à la prise murale ne dépasse pas 15 ampères.
- \* Ne jamais introduire un objet quelconque dans l'appareil à travers les fentes du boîtier, car ils pourraient être en contact avec des points de tension dangereux ou court-circuiter des pièces, ce qui pourrait entraîner un risque d'incendie ou de choc électrique.
- \* Ne jamais répandre un liquide quelconque sur l'appareil. Si un liquide ou un objet solide tombe dans le boîtier, débrancher l'appareil et le faire vérifier par du personnel qualifié avant de reprendre l'utilisation.
- \* Foudre - Pour une protection supplémentaire de cet appareil vidéo lors d'un orage ou s'il n'est pas employé et laissé sans surveillance pendant de longues périodes, le débrancher de la prise murale. Ceci évite tout endommagement au projecteur par la foudre ou par des impulsions sur le secteur.
- \* Avant de débrancher le projecteur, réduire la chaleur de la lampe en commutant le projecteur en mode d'attente et laisser refroidir la lampe du projecteur pendant 15 minutes au moins. Puis le projecteur peut être débranché par l'interrupteur secteur.

### L'Installation

- \* Ne pas placer le projecteur sur un chariot, un support ou une table instable. Le projecteur risquerait de tomber causant des dégâts sérieux au projecteur.
- \* Ne pas utiliser le projecteur à proximité d'eau.
- \* N'utiliser que le cordon d'alimentation fourni avec votre projecteur. Bien qu'ils se ressemblent, d'autres cordons d'alimentation n'ont pas subi des tests de sécurité dans l'usine et pour cette raison ils ne peuvent pas être utilisés pour actionner le projecteur. Si vous avez besoin d'un cordon d'alimentation de remplacement, contactez votre agent.
- \* Les fentes et les ouvertures pourvues dans le boîtier et au dos ou sur le fond, sont destinées à la ventilation. Pour assurer un fonctionnement fiable du projecteur et le protéger de toute surchauffe, ses ouvertures ne doivent être ni obstruées ni recouvertes. Les ouvertures ne devraient jamais être obstruées en plaçant l'appareil sur un lit, un divan, un tapis ou toute autre surface similaire. L'appareil ne devrait jamais être placé près ou au-dessus d'un radiateur ou autre source de chaleur. Ce projecteur ne doit pas être installé dans une installation encastrée ou fermée, sauf si une ventilation suffisante est assurée.
- \* Laisser suffisamment d'espace autour du projecteur et ne pas obstruer la circulation de l'air. Ne pas mettre des feuilles libres ou d'autres objets plus près de 11 cm du projecteur.

### Entretien et Réparation

Ne pas essayer de réparer le projecteur vous-même, puisque ouvrir le boîtier ou l'enlèvement des blindages peuvent vous exposer à une puissance électrique dangereuse et au risque d'une décharge électrique.

Contactez le service technique qualifié dans les cas suivants :

- Si le cordon secteur ou la prise de courant est endommagé ou effiloché.
- Si on a répandu du liquide dans le projecteur.
- Si l'appareil a été exposé à la pluie ou à de l'eau.
- Si l'appareil ne fonctionne pas normalement, bien que les instructions soient correctement suivies. Ne régler que les commandes décrites dans les instructions de fonctionnement, car un mauvais

réglage d'autres commandes peut entraîner des dégâts et souvent nécessiter un travail important par un technicien qualifié pour remettre l'appareil en conditions de fonctionnement normal.

- Si l'appareil est tombé ou si le boîtier est endommagé.
- Si l'appareil présente des changements nets de performance, indiquant un besoin de réparation.

**Pièces de rechange** - Lorsqu'on a besoin des pièces de rechange, veiller à ce que le technicien de service utilise des pièces d'origine BARCO ou des pièces équivalentes autorisées qui ont les mêmes caractéristiques que la pièce d'origine BARCO. Un remplacement par des pièces de rechange non autorisées peut nuire à la performance et la fiabilité, entraîner incendies, chocs électriques ou d'autres dangers. L'utilisation de pièces de rechange non autorisées peut annuler la garantie.

**Vérification de sécurité** - Lorsqu'un service ou une réparation sur ce projecteur est terminé, demander au technicien de service de faire les vérifications de sécurité pour s'assurer que le projecteur est en bon état de fonctionnement.

Le projecteur emploie une lampe halogène à vapeurs métalliques de 1500 W. Remplacer la lampe par une lampe de projection quelconque peut causer la surchauffe ou une qualité de l'image inacceptable. N'utiliser que des lampes de projection indiquées par BARCO ou un agent autorisé de BARCO ou un service.

### Nettoyage

Débrancher l'appareil de la prise avant tout nettoyage. Ne pas utiliser des détergents liquides ou des aérosols. Utiliser un chiffon humide pour le nettoyage.

Pour garder au boîtier son aspect neuf, le nettoyer régulièrement avec un chiffon doux. Des tâches tenaces peuvent être enlevées avec un chiffon humidifié par une solution de détergent doux. Ne jamais utiliser des solvants forts, tels que du 'thinner' ou du benzène, ni des produits de nettoyage abrasifs, car ils pourraient endommager le boîtier.

Pour garantir les meilleures performances et définition, les objectifs de projection sont spécialement traités avec un revêtement anti-reflets. En conséquence : éviter de toucher les objectifs. Pour enlever la poussière de l'objectif, utiliser un chiffon sec et doux. Ne pas utiliser de chiffon humide, de solution détergente ou de diluant. Respecter la méthode de nettoyage des objectifs indiquée dans l'annexe B au manuel d'utilisateur.

### Ré-emballage

Conserver l'emballage et les produits d'emballage d'origine, ils seront d'un précieux secours s'il avère utile d'expédier le projecteur. Pour une protection maximale, ré-emballer l'appareil de la même manière qu'à l'usine.

### Eclairage

Pour garantir la meilleure qualité possible de l'image projetée, il est essentiel que l'éclairage ambiant incident sur l'écran soit réduit au strict minimum.

Lors de l'installation du projecteur et de l'écran, il faut veiller à éviter toute exposition directe de l'écran à la lumière ambiante. Éviter tout éclairage perturbateur sur l'écran par des rayons du soleil ou des éclairages fluorescents.

L'utilisation d'un éclairage ambiant contrôlable, tel qu'un spot incandescent ou un variateur de lumière est recommandée pour obtenir un éclairage correct de la pièce. Dans la mesure du possible veiller à ce que les parois et le sol de la pièce dans laquelle le projecteur doit être installé soient non-réfléchissants et de couleur foncée. Des surfaces brillantes réfléchissent et diffusent la lumière ambiante et par conséquent réduisent le contraste de l'image sur l'écran.

# 2

## UNPACKING AND DIMENSIONS

### Unpacking

To open the banding, pull on the clip as shown in the first drawing.

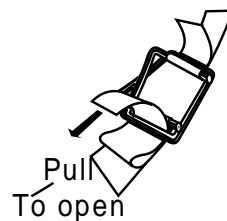

Take the projector out of its shipping carton and place it on a table.

For transportation, the projector is mounted on a wooden board with 3 bolts. Use a 13 mm wrench to remove these bolts.

When using the projector as a table mounted configuration, always mount the 3 supporting feet (see drawing below). These feet are mounted on the same wooden board. Each foot contains one metal part and two plastic parts. To remove the feet, first turn out both plastic parts. To remove the metal parts from the board, remove the retaining bolts. Save these bolts because these bolts must be used to mount the feet to the projector. Mount first the metal parts with the removed bolts and turn in then both plastic parts to finish the feet.

*Warning : To prevent overheating of the projector as table mounted, always remove the wooden board and turn in the 3 supporting feet to*

*allow air circulation via the built-in dust filter at the bottom.*

Save the original shipping carton and packing material, they will come in handy if you ever have to ship your projector. For maximum protection, repack your projector as it was originally packed at the factory.

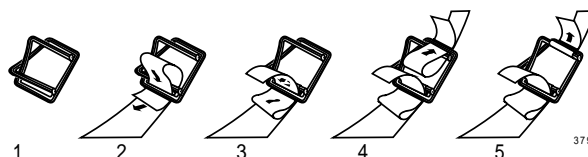

Contents of the shipped box :

- 1 BARCOVISION 8200
- 1 remote control unit RCU + 9V battery
- 1 power cable with outlet plug type CEE7.
- 1 owner's manual
- 3 supporting feet (built up in 3 parts)

### Projector dimensions

(units : mm)

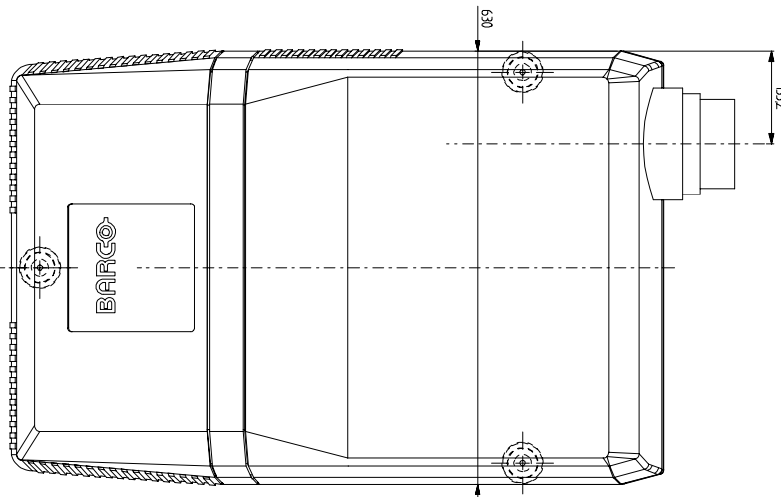
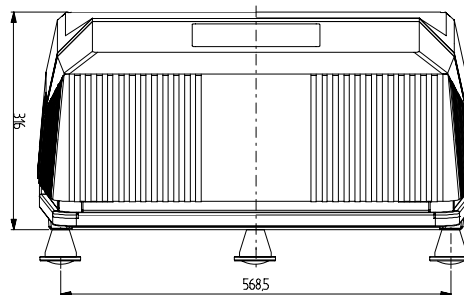
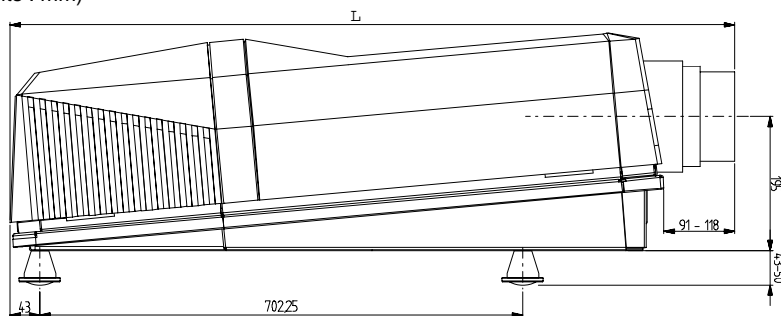

Some examples of lenses :

Name lens (*)	Lmin mm (inch)	Lmax mm (inch)
HD(1.2:1)	1072 (42.20)	1087 (42.79)
HD(2.2:1)	1043 (41.06)	1070 (42.12)
HD(3.3:1)	1017 (40.04)	1072 (42.20)
HD(4.0:1)	1022 (40.24)	1162 (45.75)
HD(5:1)	1082 (42.60)	1202 (47.32)
HD(7:1)	1252 (49.29)	1372 (54.02)
HD(1.5-3:1)	1252 (49.29)	1355 (53.35)
HD(3-5.3:1)		

(\*) More info about lenses, see appendix B.

### Battery installation in the RCU.

A battery (not yet installed to save the battery life time) is delivered inside the plastic bag with the power cord. To install the battery, remove the battery cover on the backside of the remote control by pushing the indicated handle a little to the bottom of the RCU. Lift up the top side of the cover at the same time (fig. 1).

Insert the new 9 V battery (type E-block or equivalent) in the lower compartment and connect the battery to the contact plate.

Insert the battery into the lower compartment and put the cover back.

*Note : projector address has to be programmed on the RCU before using the RCU (see chapter 'Controlling').*

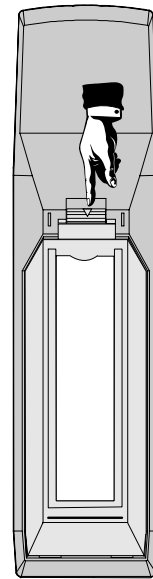

fig.1

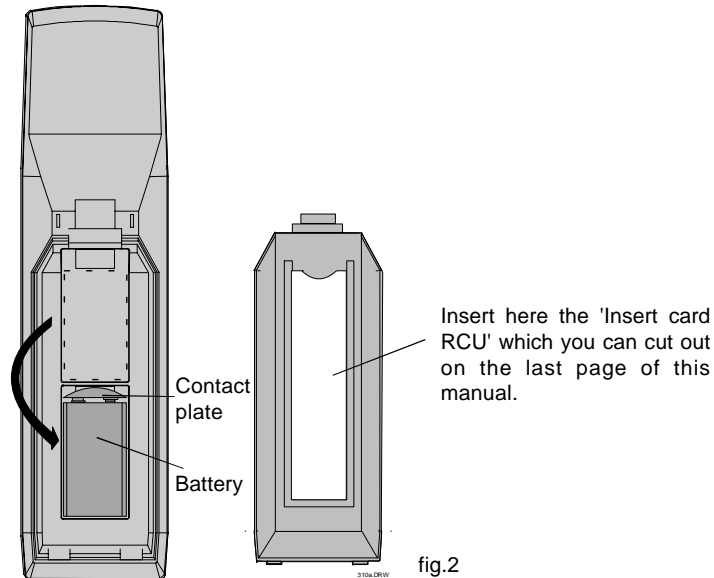

fig.2

# 3

## INSTALLATION GUIDELINES

### Installation guidelines

Careful consideration of things as image size, ambient light level, projector placement and type of screen to use are critical to the optimum use of the projection system.

Max. ambient temperature : 40 °C.

Min. ambient temperature : 0°C.

The projector will not operate if the ambient air temperature falls outside this range (0°C - 40°C).

#### \* Environment

Do not install the projection system in a site near heat sources such as radiators or air ducts, or in a place subject to direct sunlight, excessive dust or humidity. Be aware that room heat rises to the ceiling; check that temperature near the installation site is not excessive.

#### \* What about ambient light ?

The ambient light level of any room is made up of direct or indirect sunlight and the light fixtures in the room. The amount of ambient light will determine how bright the image will appear. So, avoid direct light on the screen.

Windows that face the screen should be covered by opaque drapery while the set is being viewed. It is desirable to install the projecting system in a room whose walls and floor are of non-reflecting material. The use of recessed ceiling lights and a method of dimming those lights to an acceptable level is also important. Too much ambient light results in a 'wash out' of the projected image. That appears as less contrast between the darkest and lightest parts of the image. With bigger screens, the 'wash out' becomes more important. As a general rule, darken the room to the point where there is just sufficient light to read or write comfortably. Spot lighting is desirable for illuminating small areas so that interference with the screen is minimal.

#### \* Which screen type?

There are two major categories of screens used for projection equipment. Those used for front projected images and those for rear projection applications.

Screens are rated by how much light they reflect (or transmit in the case of rear projection systems) given a determined amount of light projected toward them. The 'GAIN' of a screen is the term used. Front and rear screens are both rated in terms of gain. The gain of screens range from a white matte screen with a gain of 1 (x1) to a brushed aluminized screen with a gain of 10 (x10) or more. The choice between higher and lower gain screens is largely a matter of personal preference and another consideration called the Viewing angle.

In considering the type of screen to choose, determine where the viewers will be located and go for the highest gain screen possible. A high gain screen will provide a brighter picture but reduce the viewing angle.

*For more information about screens, contact your local screen supplier.*

#### \* What image size? How big should the image be?

The projector is designed for projecting an image size (video) from 1.00m (3.3ft) to 10.00m (39ft) with a aspect ratio of 4 to 3.

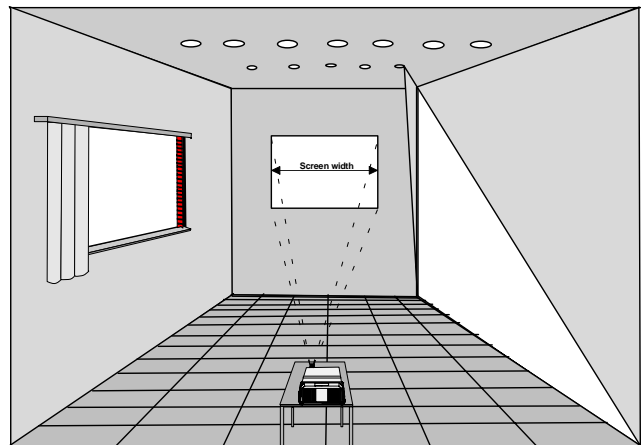
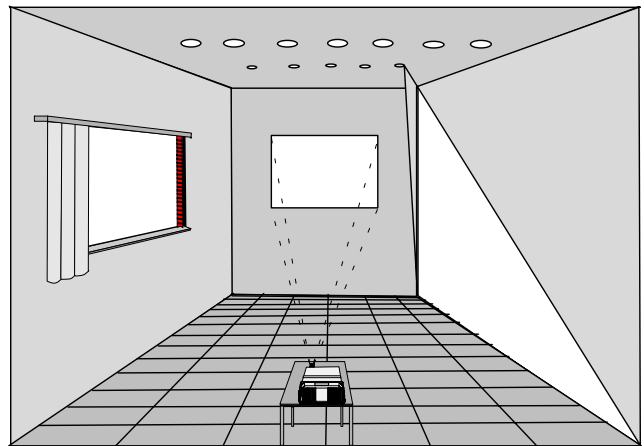

\* Where to install the projector?

Definitions of the Abbreviation on drawings

B = Distance between ceiling and top of the screen or between floor and bottom of the screen.

A = Correction value, distance between bottom side of projector (without feed) and middle of the lens. Value to be subtracted from B to obtain the correct installation position. (A value is a constant value for all screen widths and type of lenses, A = 195 mm.)

CD = Total distance between projector and ceiling or projector and floor.

SW = Screen width.

SH = Screen height (image height).

PD = Projector Distance, distance between screen and projector.

Inputs and computer video format input compatibility :

Some examples :

- VIDEO and S-VIDEO
- COMPONENT VIDEO
- RGB ANALOG with STANDARD SYNC (SYNC ON GREEN or SEPARATE SYNC)
- RGB ANALOG with TRI-LEVEL SYNC (SYNC ON GREEN or SEPARATE SYNC)
- VGA : 640 x 480 pixels
- MAC : 640 x 480 pixels
- Super VGA : 800 x 600 pixels (only in a window of 756 x 556 pixels)

Lens type selection.

- a) determine the required screen width.
  - b) determine the approximate position of the projector in the projection room with regard to the screen and measure the projector-screen distance (PD).
  - c) use the lens formulas in appendix B to find the best corresponding PD with regard to the measured projector-screen distance for the required screen width.
- The desired lens is determined (the order number is given in the table in the same appendix B).  
Start the installation procedure for the projector as described in the manual.

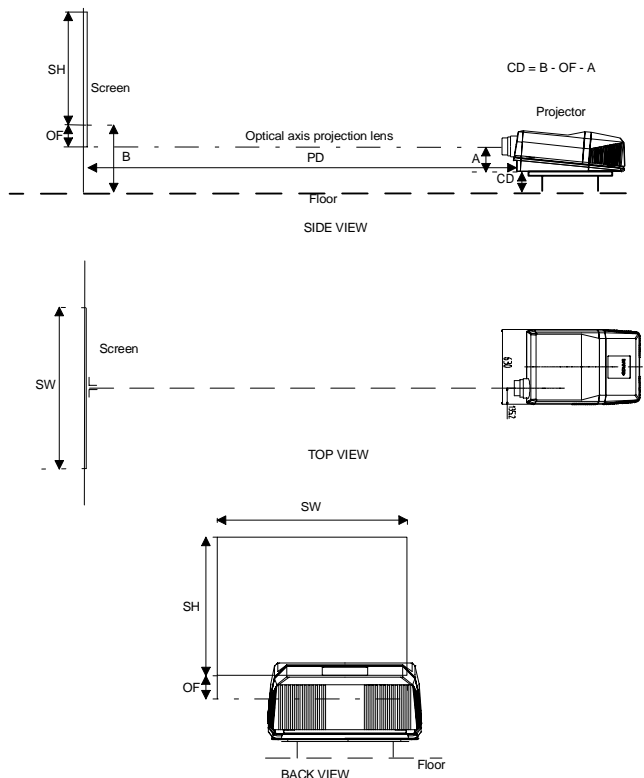
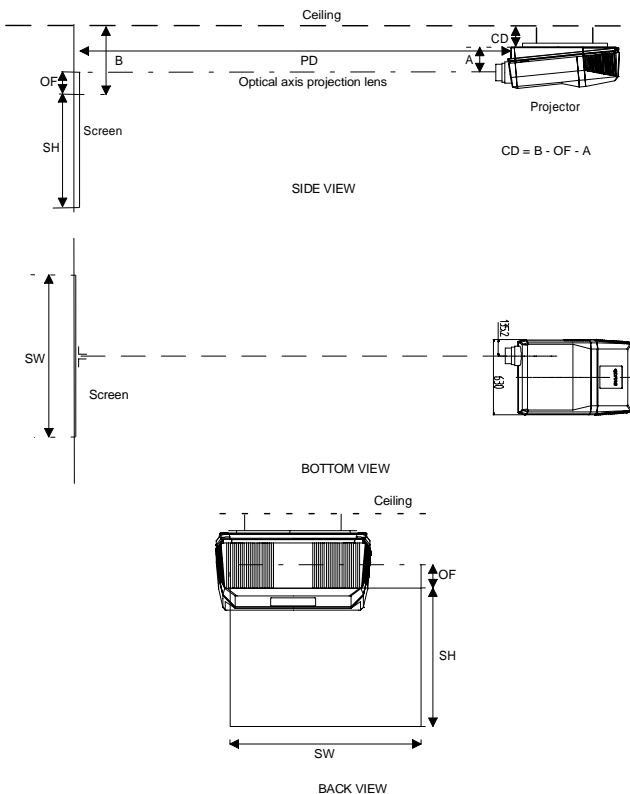

\* How to install a projection lens?

The projector is supplied without any lens.  
The following lenses are available as an option :

- HD(1.2:1)
- HD(2.2:1)
- HD(3.3:1)
- HD(4.0:1)
- HD(5:1)
- HD(7:1)
- HD(1.5-3:1)
- HD(3.0-5.3:1)
- WHD(3.5:1)

How to install the lens?

Remove the foam rubber in the opening of the lens holder.

- Take the new lens out of its shipping carton and remove the lens covers.
- Turn the lens into the lens holder by turning clockwise.
- Focus the lens (see appendix B) and secure the correct position with the fastener ring by turning this ring clockwise.

# 4

## LOCATION AND FUNCTIONS OF CONTROL

### Front panel terminology

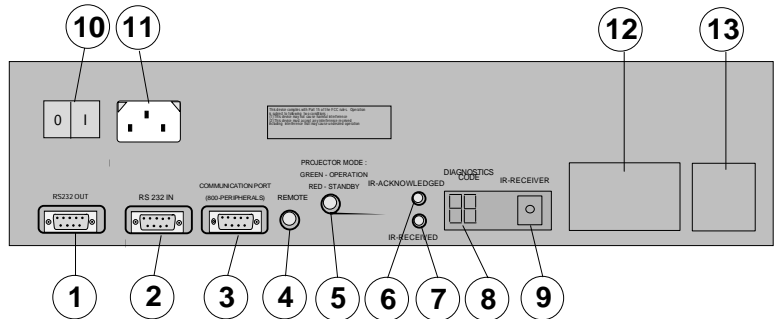

- 1** **RS232 IN** : to allow communication with external computer, e.g. IBM PC or compatible, Macintosh ...
- 2** **RS232 OUT** : used to connect to next projector, RS232IN plug (communication link for PC or MAC to the next projector).
- 3** **Communication port** : allows communication with the 800 peripherals.
- 4** **Remote** : remote input for wired remote control.
- 5** **Projector mode indication** : indicates the status of the projector.  
no lighting up : power switch is not pressed.  
red lighting up : power switch is pressed, projector in stand by mode.  
green lighting up : projector in operational mode.
- 6** **IR-Acknowledged** : IR signals are recognized.
- 7** **IR-Received** : IR signals are received but not recognized by the projector.
- 8** **Diagnostics code** : a) source number  
b) error code : a two digits error code is displayed when something goes wrong inside the projector.
- 9** **IR receiver** : receiver for control signals transmitted from the RCU.
- 10** **Power switch** : '1' = on, '0' = off
- 11** **Power input** : autoranging from 100 to 240 Vac.
- 12** **Identification plate** : name, serial number, art. number.
- 13** **Voltage identification plate**

### Control Panel Terminology

#### a. Local keypad

Gaining access

The keypad is located behind a door, screened with the name of the projector.

To open the door, push once on the indicated side of the door and turn it to the front side of the projector.

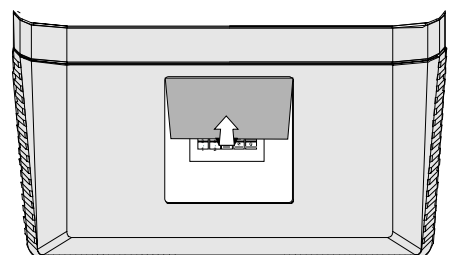
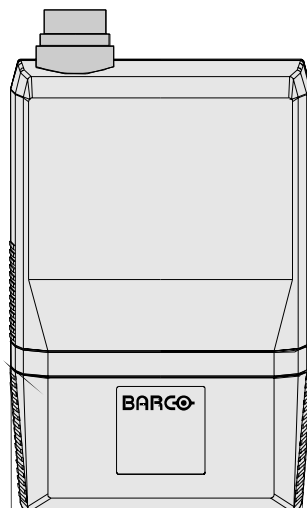

b. Remote control

This remote control includes a battery powered infrared (IR) transmitter that allows the user to control the projector remotely.

This remote control is used for source selection, control, adaptation and set up. It includes automatic storing of :

- picture controls (Brightness, Sharpness...)
- settings

Other functions of the remote control are :

- switching between standby and operational mode.
- switching to "pause" (blanked picture, full power for immediate restarting)
- direct access to all connected sources.
- variable adjustment speed : when pushing continuously on the control disk or the picture keys, the adjustment will be executed in an accelerated fashion.

Remote Control (RCU)

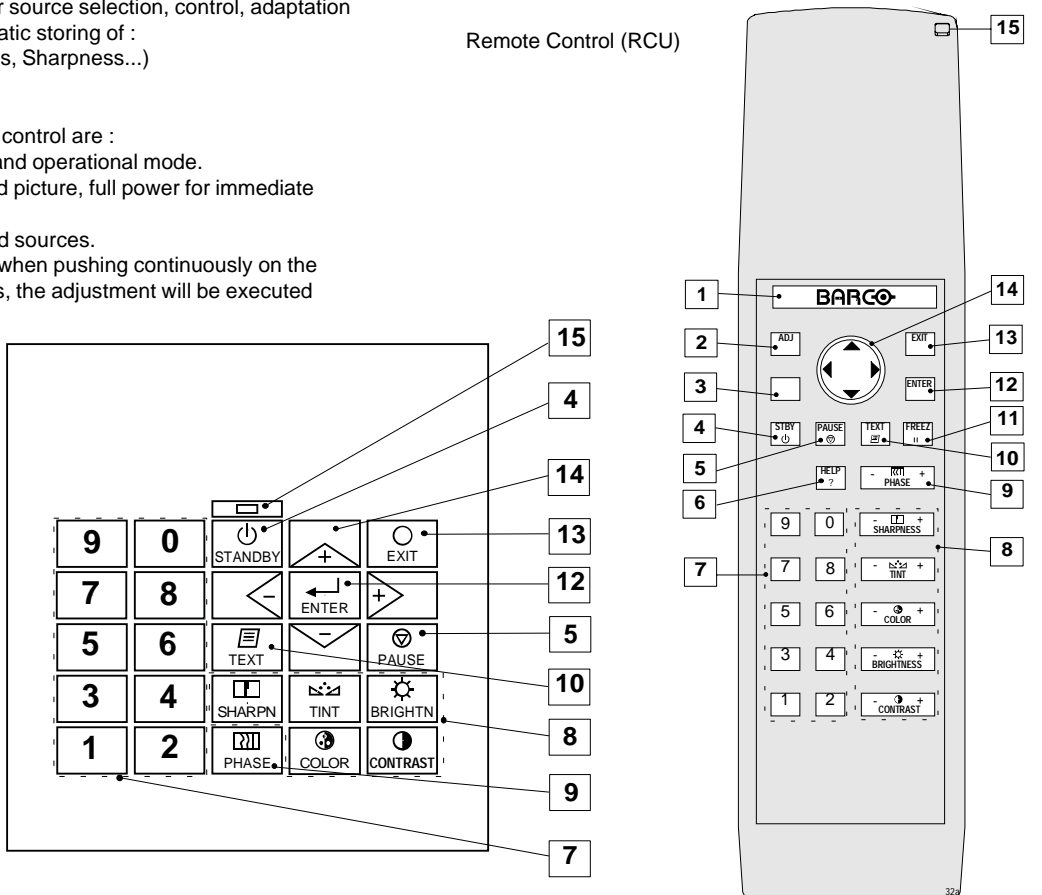

Terminology

- 1 **Back light key** : when activated, all keys will be lighted up and visible in the dark.
- 2 **ADJ.** : ADJUST key, used to display on line help while in the adjustment mode.
- 3 **Address key (sunk key)**, to enter the address of the projector (between 0 and 9). Press the sunk address key with a pencil, followed by pressing one digit button between 0 and 9.
- 4 **STBY** : stand by button - to start projection when the power switch is switched on.  
- to switch off the projector without switching off the power switch.
- 5 **PAUSE** : to stop projection for a short time, press 'PAUSE'. The image disappears but full power is retained for immediate restarting.
- 6 **Help** : on line help information
- 7 **Digit buttons** : direct input selection.
- 8 **Picture controls** : use these buttons to obtain the desired picture analog level (see also 'Controlling').
- 9 **PHASE** : used to remove the instability of the image.
- 10 **TEXT** : when adjusting one of the image, e.g. controls during a meeting, the displayed bar scale can be removed by

pressing 'TEXT' key first. To re-display the bar scale on the screen, press 'TEXT' key again. 'TEXT' key only active in operational mode.

- 11 **FREEZ** : press to freeze the projected image.
- 12 **ENTER** : to start up the adjustment mode or to confirm an adjustment or selection in the adjustment mode.
- 13 **EXIT** : to leave the adjustment mode or to scroll upwards when in the adjustment mode.
- 14 **Control disk (on RCU) or '+' and '-' keys (cursor keys)**: to make menu selections when in the adjustment mode. The control disk can move forward, backward, to the right or to the left.  
Comparison between control disk movement and the use of the cursor keys on the local keypad :  
RCU = local keypad  
control disk up = '+' key up  
control disk down = '-' key down  
control disk to the right = '+' key right  
control disk to the left = '-' key left  
Use the '+' and '-' keys (cursor keys) : to increase or decrease the analog level of the image controls when they are first selected.
- 15 **RC operating indication** : lights up when a button on the remote control is pressed. (This is a visual indicator to check the operation of the remote control)



# 5

## INSTALLATION SET UP

The projector can be installed to project images in four different configurations : front/table, front/ceiling, rear/table and rear/ceiling.

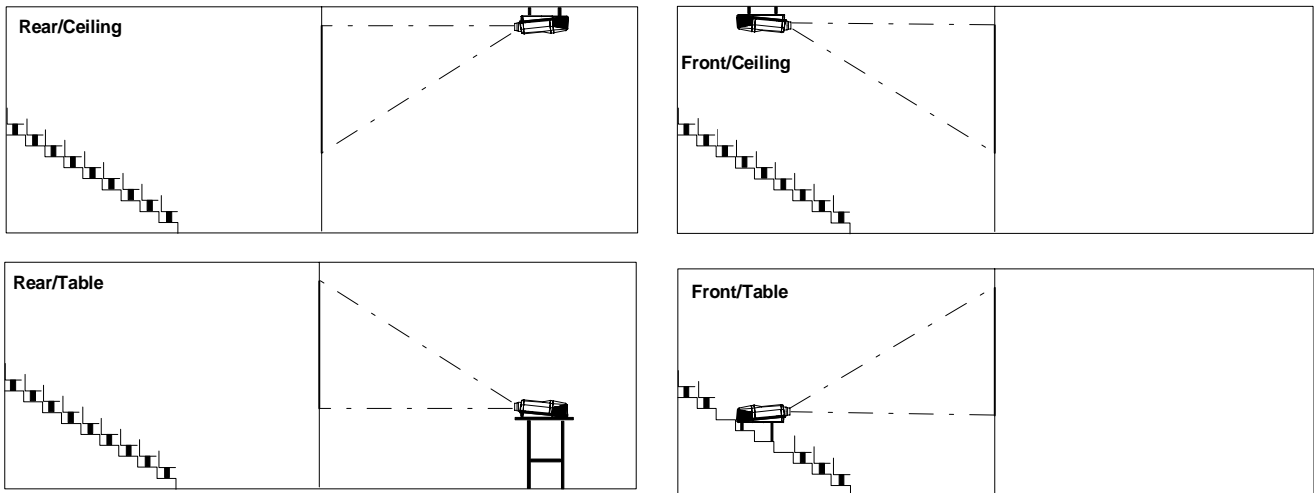

When switching on and the projector displays an image as illustrated below, an adaptation of the projector configuration is required.

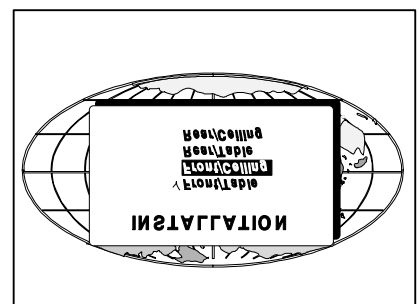
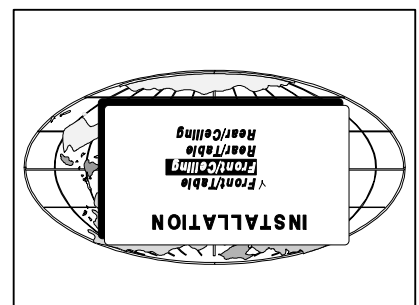
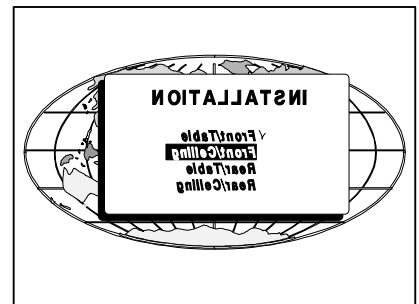

The projector's configuration can easily be changed with the RCU or the local keypad. Start up the menu driven procedure by pressing ENTER to display the Main Menu. To change the Configuration, enter the adjustment mode by pushing **ENTER**.

## Installation Set Up

Push the control disk up or down to highlight Systems Settings and press ENTER.

**ENTER** displays the System Settings menu.  
**EXIT** returns to operational mode.

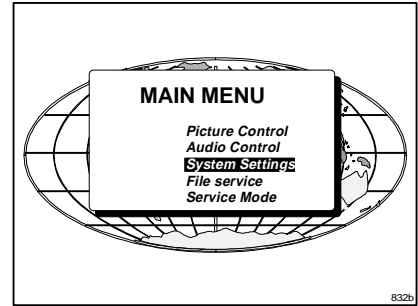

Push the control disk up or down to highlight Installation and press ENTER.

**ENTER** displays the Installation menu.  
**EXIT** returns to the Main menu.

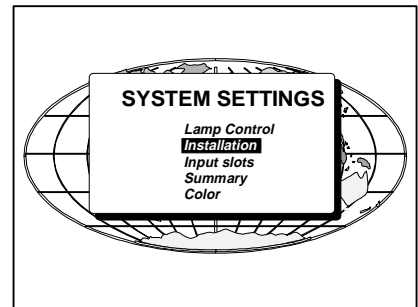

A marker indicates the actual configuration. Push the control disk up or down to select the corresponding configuration with regard to the projector environment. Press **ENTER** to confirm your selection. The marker jumps to the selected item and the image changes. Press **EXIT EXIT EXIT** (3x EXIT) to return to operational mode.

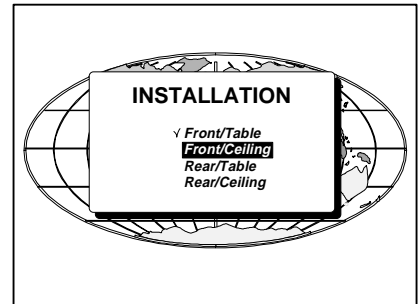

# 6

## CONNECTIONS

### Power (mains) cord connection

Use the supplied power cord to connect your projector to the wall outlet. Plug the female power connector into the male connector at the front of the projector.

The power input is auto-ranging from 100 to 240 VAC. This projector may be connected to an IT-power system.

### Fuses

Warning

For continued protection against fire hazard :

- refer replacement to qualified service personnel
  - ask to replace with the same type of fuse.
- Fuse type : T12.5 AH/250V

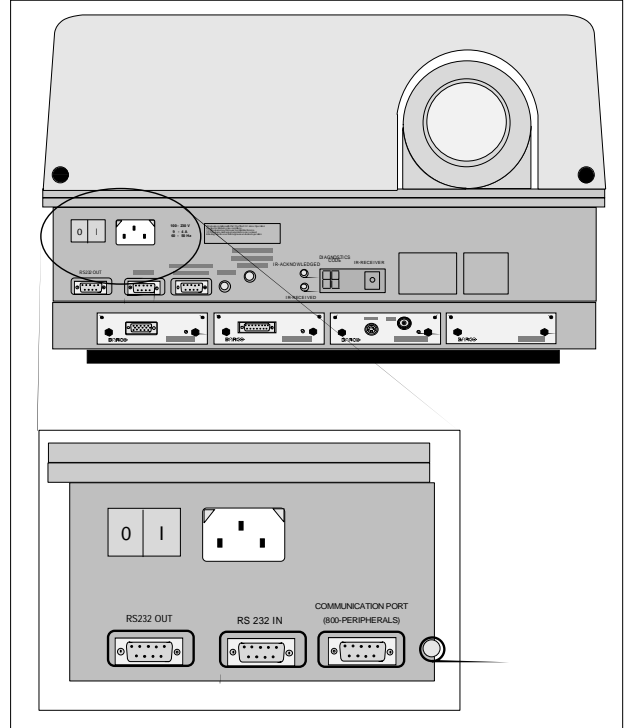

### Switching on

Use the power switch to switch on.

When '0' is visible, the projector is switched off.

When '1' is visible, the projector is switched on.

When switching on with the power switch, the projector starts in the stand by mode. The projector mode indication lamp is red.

To start image projection :

- a. press the 'Stand by' button on the local keypad or on the remote control. The projector mode indication lamp will be green.
- b. press a digit button to select an input source. The projector mode indication lamp will be green.

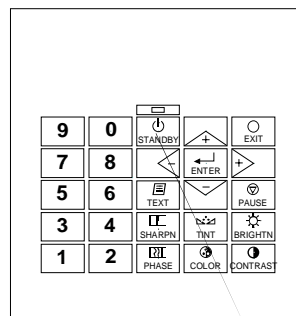

Stand by button

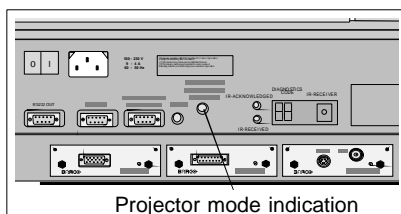
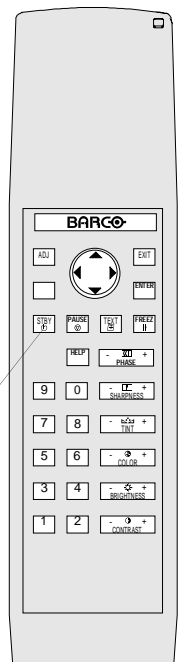

Projector mode indication

## Connections

When the total run time of the lamp is 970 hours or more, the following message will be displayed for 1 minute. This message will be repeated every 30 minutes. Press EXIT to remove the message before the minute is over.

When the total run time of the lamp is 1000 hours or more, the following message, with the exact run time is displayed on the screen.

*Lamp run time is 1000 hours. Operating the lamp longer than 1000 hours may damage the projector. Please replace the lamp.*

When OK (ENTER) is pressed to go on, the warning will be repeated every 30 min.

The total lifetime of the lamp for a safe operation is 1000 hours max. (normal power mode). Do not use it longer. Replace always with a same type of lamp. Call a BARCO authorized service technician for lamp replacement.

**Warning : Using a lamp for more than 1000 hours is dangerous, the lamp could explode.**

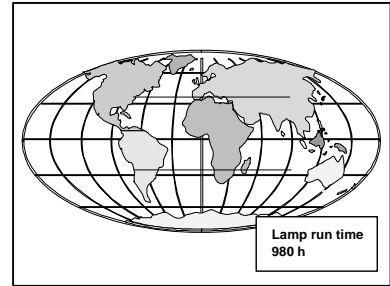

## Switching to stand-by.

When the projector is running and you want to go to stand-by, press the stand-by key.

## Switching off

To switch off:

- press first **STANDBY** key and let cool down until the fans stop blowing ( or at least 15 min).
- switch off the projector with the power switch.

**WARNING : When switching to standby, never restart projection (hot restrike) within the first 3 minutes to avoid damage to the lamp.**

## Input connections.

The projector has modular input facilities. The input slots can be filled up with the following modules :

Video, S-video (PAL, SECAM, NTSC) input  
order no. R9827900  
RGBS/RGsB analog input  
order no. : R9827910  
RGB3S/RG3sB input  
order no. : R9827920  
Component Video input  
order no. : R9827930

The sequence of insertion has no importance, except when using a RCVDS or VS05. It is even perfectly possible to insert several input modules of one type.

Note : When using RCVDS05 or VS05, the input configuration of the projector must be as follows:

- Slot 1 : video input module
- Slot 2 : RGB analog input module
- Slot 3 : Component input module

## Input module insertion into the projector :

- Power down the projector and disconnect the power cord from the wall outlet.
- Remove the dummy plate covering the chosen input slot by turning out both screws.
- Slide the input module in the free slot. Insure the module is seated correctly in the guide grooves.
- Press on both handles of the input module until the module plug seats in the connector of the projector.
- Secure the input module by tightening both retaining screws.
- Reconnect the power cord to the wall outlet and switch on the projector.

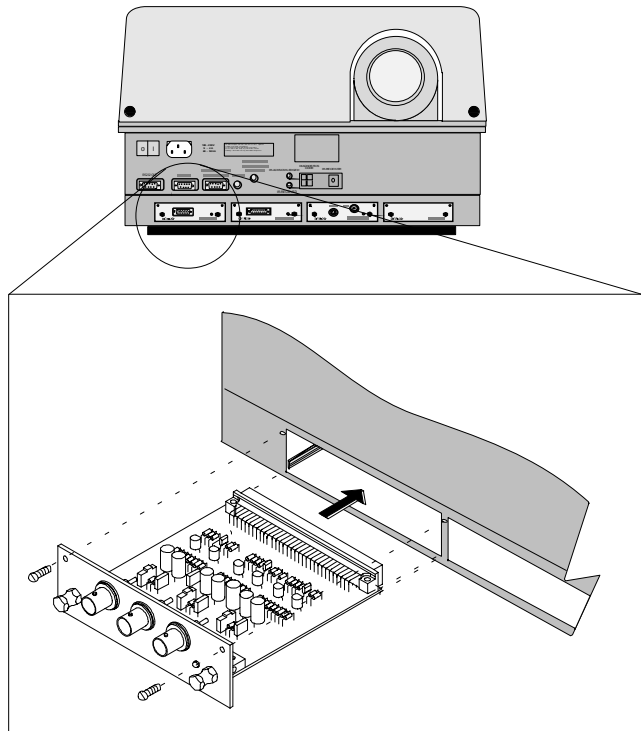

The new installed module can be selected with the digit buttons on the RCU or the local keypad.

### Video/S-video input module

To the Video input :

Composite video signals from a VCR, OFF air signal decoder, etc...  
1 x BNC 1.0Vpp ± 3 dB

To the S-Video input :

Separate Y-luma/C-chroma signals for higher quality playback of Super VHS-signals.

1 x 4 pins plug (mini DIN)

pin configuration :

- 1 ground luminance
- 2 ground chrominance
- 3 luminance 1.0 Vpp ± 3 dB
- 4 chrominance 282 mVpp ± 3 dB

Input selection :

Key in the corresponding slot number on the RCU or the local keypad. Depending on the priority setting in the Input slots menu, Video or S-Video will be displayed. If the wrong source type is displayed, start up the adjustment mode by pressing **ADJUST** or **ENTER**.

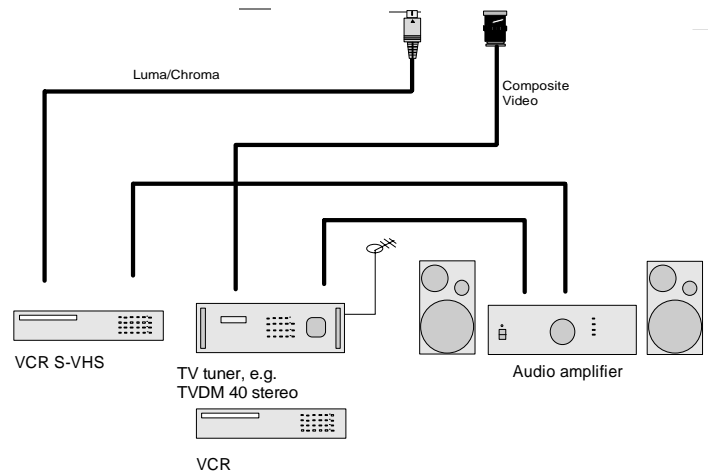
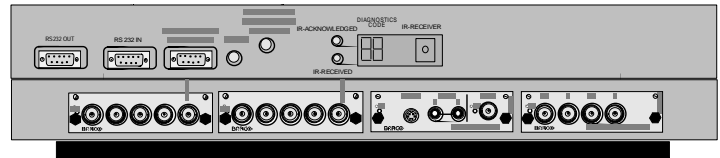
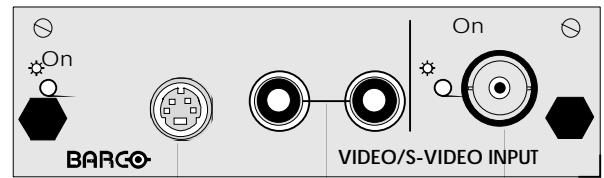

Push the control disk up or down to highlight System settings and press **ENTER** to display the 'System Settings menu'. **EXIT** returns to operational mode.

Use the control disk to select 'Input Slots' by pushing it up or down and press **ENTER**. The internal system will scan the inputs and displays the result in the 'Input Slots menu'.

Push the control disk up or down to select the corresponding (video or S-video) input slot number. To change the priority between Video and S-Video, press **ENTER** key to toggle.

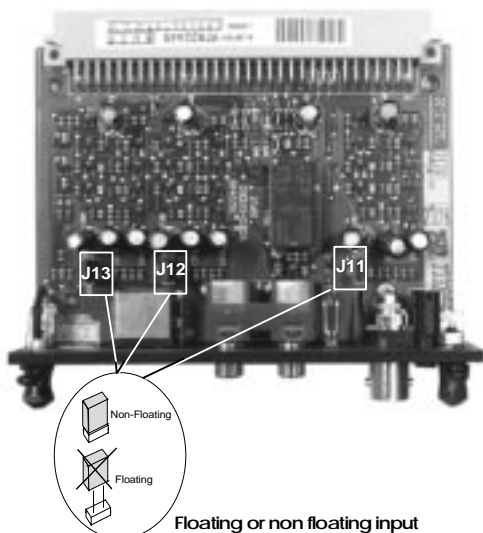
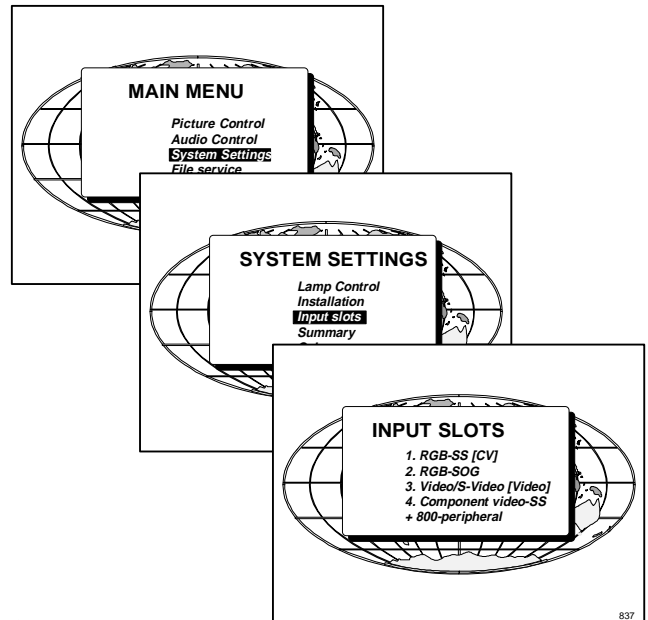

#### Straps on module level.

Floating or non-floating input.

Video input :

J11 : strap "yes" : non floating strap "no" : floating

S-Video input :

J12 : strap "yes" : non floating strap "no" : floating

J13 : strap "yes" : non floating strap "no" : floating

Factory preset : strap on, input non floating.

**RGB analog input module.**

RGB analog input terminals with separate Horizontal and Vertical sync inputs(RGB-HV), with Composite sync input(RGB-S) or with Sync signals on green(RGsB).

Always use an interface when a computer and local monitor have to be connected to the projector. Interfaces to be applied :

Universal analog interface.

Order number : R9826100.

RGB 120 MHz analog interface.

Order number : R9826570.

VGA interface

Order number 120V : R9828079.

Order number 230V : R9828070

MAC interface

Order number 120V : R9828059

Order number 230V : R9828050

MAGIK interface

Order number 120V : R9828129

Order number 230V : R9828120

RGBS/RGsB analog : 5 x BNC

Red : 0.7 Vpp ± 3 dB

Blue : 0.7 Vpp ± 3 dB

Green : 0.7 Vpp ± 3 dB

1 Vpp ± 3 dB if sync on green

Vert. sync : 1 Vpp to 4 Vpp ± 3 dB

Hor. sync / Composite sync :

1 Vpp to 4 Vpp ± 3 dB

All input signals are always 75 ohm terminated, even in the "not selected" mode.

**RGB input selection :**

Key in the corresponding slot number on the RCU or the local keypad.

**Straps on module level :**

Floating or non-floating input.

Red : J3 : strap "yes" : non floating strap "no" : floating

Green : J4 : strap "yes" : non floating strap "no" : floating

Blue : J5 : strap "yes" : non floating strap "no" : floating

H/C : J6 : strap "yes" : non floating strap "no" : floating

V : J7 : strap "yes" : non floating strap "no" : floating

Factory preset : strap "yes", non floating input

Sync selection : strap on module level.

J8 : see drawing

Factory preset : separate sync.

Sync selection on the Input Slots menu.

The horizontal sync input can be set as separate sync input or as separate sync + video input. To change this setting, press **ENTER** key to start up the Adjustment mode..

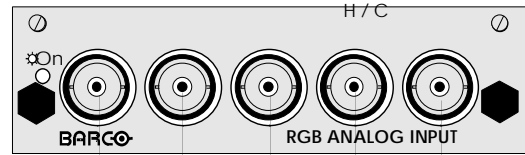
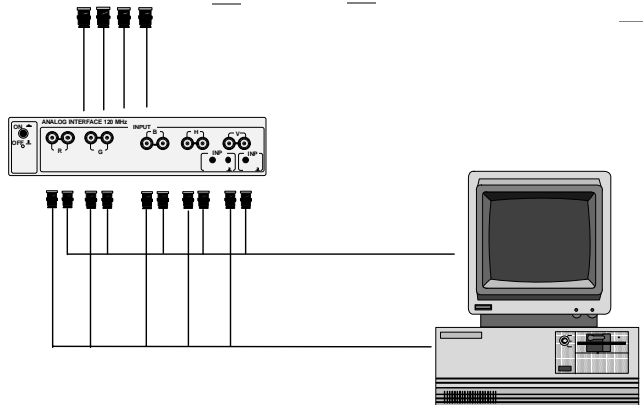
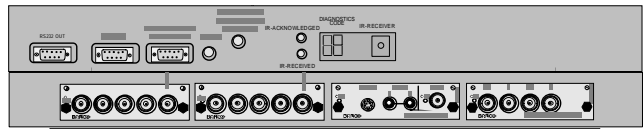

Red Green Blue  
Vert. sync  
Hor. sync or Composite sync

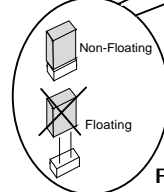
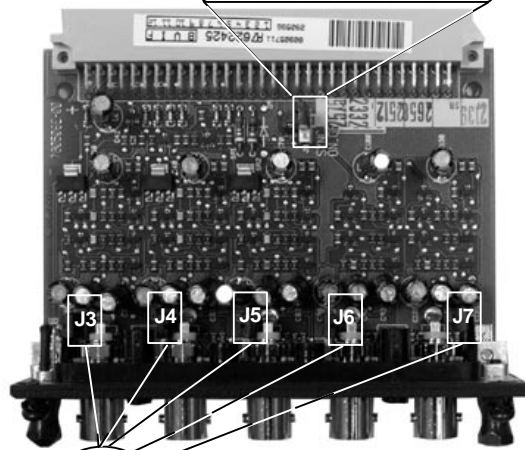
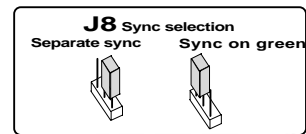

Floating or non floating input

Push the control disk key up or down to select *System Settings* and press **ENTER**.

Use the control disk to select Input Slots by pushing up or down and press **ENTER**. The internal system will scan the inputs and displays the result in the Input Slots menu.

Push the control disk up or down to select the corresponding RGB input slot. To change the sync priority for Sync separate, press **ENTER** key to toggle between CV and CS or HS&VS.

Possible indication :

- RGB-SS [CV]** = separate sync is composite video signal on H/C input.
- RGB-SS [CS or HS&VS]** = separate sync is composite sync or horizontal and vertical sync.
- RGB-SOG** = sync on green.

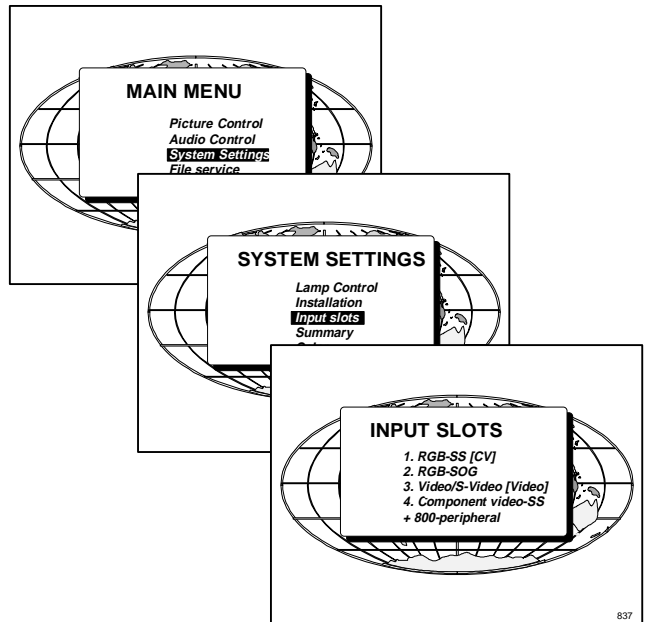

**Component input module.**

Connect your component signals (Y-luma, R-Y and B-Y), e.g. a professional VCR to the Component input module.

Component video : 4 x BNC

R-Y : 0.7 Vpp ± 3 dB

B-Y : 0.7 Vpp ± 3 dB

Y : 0.7 Vpp ± 3 dB

1 Vpp ± 3 dB if Tri-level sync on green

Composite sync : 1 Vpp to 4 Vpp ± 3 dB

All input signals are always 75 ohm terminated, even if the module is "not selected".

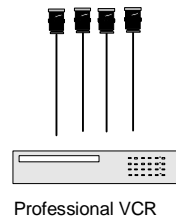
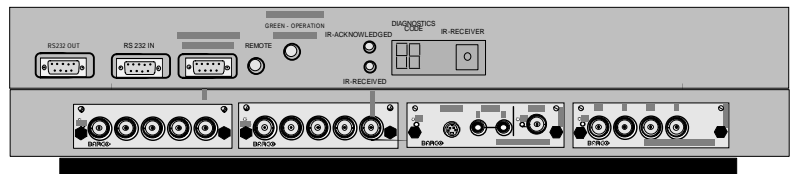
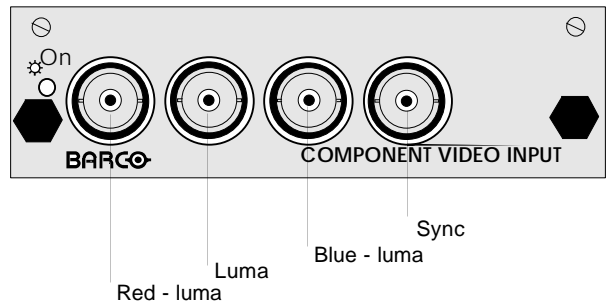

**Component input selection :**

Key in the corresponding slot number on the RCU or the local keypad.

**Indication on the input slot menu :**

- Component Video-SS = Component video with separate sync
- Component Video-SOY = Component video with sync on Y
- Component Video-3LSS = Component video with 3 level separate sync
- Component Video-3LSOY = Component video with 3 level sync on Y

**Straps on module level :**

Floating or non-floating input.

R-Y : J3 : strap "yes" : non floating strap "no" : floating  
 Y : J4 : strap "yes" : non floating strap "no" : floating  
 B-Y : J5 : strap "yes" : non floating strap "no" : floating  
 S : J6 : strap "yes" : non floating strap "no" : floating

Factory preset : strap "yes", non floating input

Sync selection.

J8 :  
 strap "no" : separate sync  
 strap "yes" : sync on Y.

J9 :  
 strap "yes" : Tri-level sync  
 strap "no" : normal sync.

Factory preset :  
 separate sync and  
 normal sync.

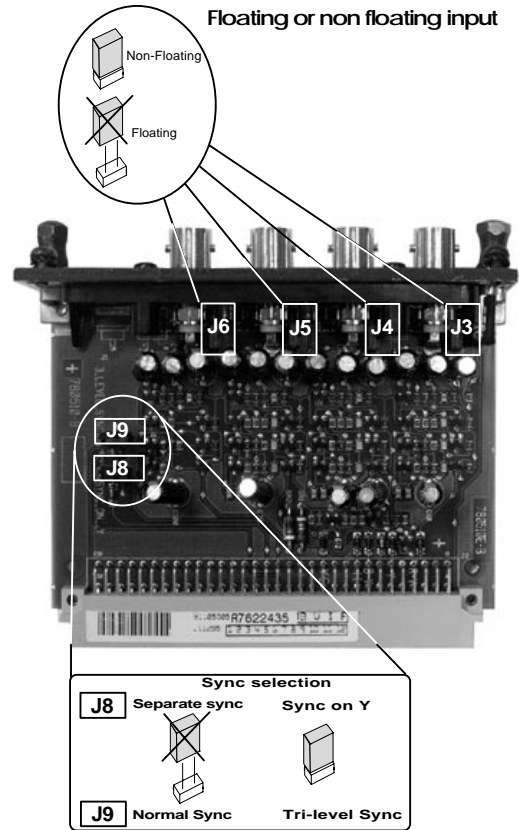

**RGB3S/RG3sB input module.**

Connect your RGB signals with Tri-level sync, e.g. a professional VCR to the RGB 3 level sync input module.

RGB3S/RG3sB analog : 5 x BNC

Red : 0.7 Vpp ± 3 dB

Blue : 0.7 Vpp ± 3 dB

Green : 0.7 Vpp ± 3 dB

1 Vpp ± 3 dB if Tri-level sync on green

Vert. Tri-level sync : 1 Vpp to 4 Vpp ± 3 dB

Hor. Tri-level sync / Composite Tri-level sync:

1 Vpp to 4 Vpp ± 3 dB

All input signals are always 75 ohm terminated, even in the "not selected" mode.

**Input selection :**

Key in the corresponding slot number on the RCU or the local keypad.

**Indication on the input slot menu :**

RGB3L-SS = RGB with separate Tri level sync.

RGB3L-SOG = RGB with Tri level sync on green.

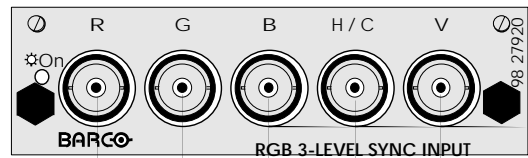

Red  
 Green  
 Blue  
 Vert. 3 level sync  
 Hor. or composite 3 level sync

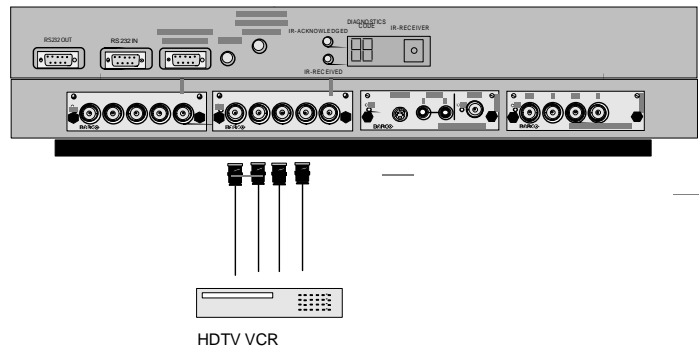



**Straps on module level :**

Floating or non-floating input.

Red :	J3 : strap "yes" : non floating	strap "no" : floating
Green :	J4 : strap "yes" : non floating	strap "no" : floating
Blue :	J5 : strap "yes" : non floating	strap "no" : floating
H/C :	J6 : strap "yes" : non floating	strap "no" : floating
V :	J7 : strap "yes" : non floating	strap "no" : floating

Factory preset : strap "yes", non floating input

Sync selection.

J8 : separate sync or sync on green.

Factory preset : separate sync.

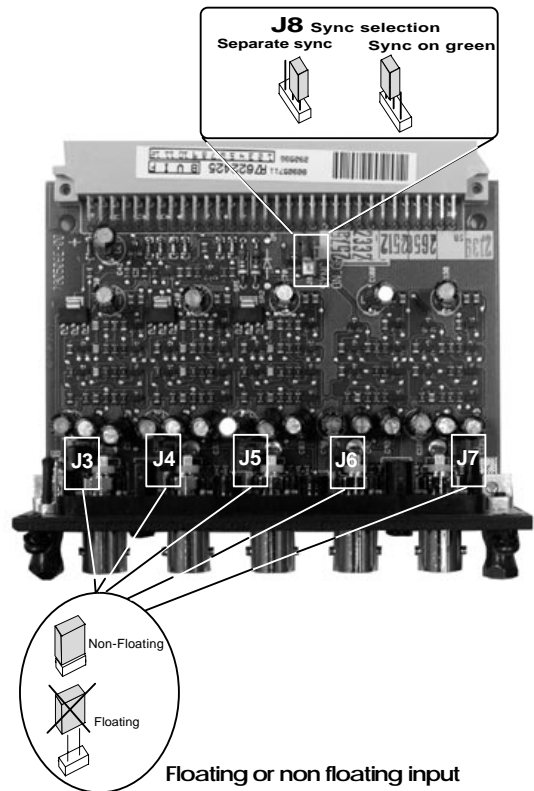

**Connecting a computer, e.g. IBM PC (or compatible), Apple Macintosh to the RS 232 input of the projector.**

The projector has a RS232 port that allows it to communicate with a computer.

Applications : remote control and VISION communications.

- a) remote control :
  - easy adjustment of projector via IBM PC (or compatible) or MAC connection.
  - allow storage of multiple projector configurations and set ups.
  - wide range of control possibilities.
  - address range from 0 to 255.
- b) VISION communications :
  - sending VISION to the projector or copying the VISION from the projector to a hard memory device.

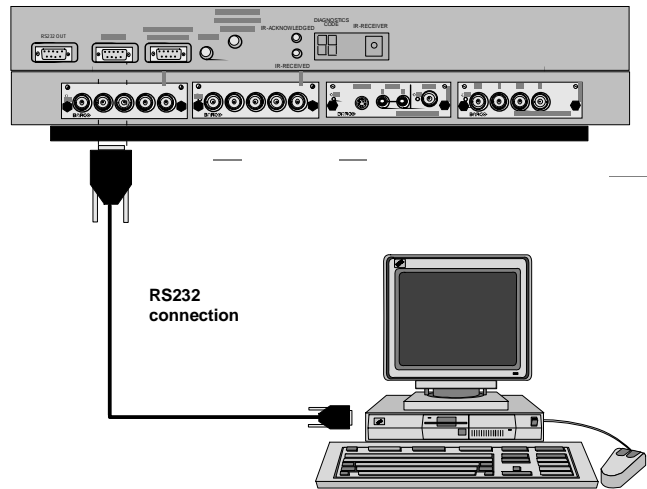

**Set up of the baud rate for communication with a computer.**

The communication speed between projector and computer, e.g. PC or MAC, has 8 possible speeds. With DIP switches S2(1,2,3) on the controller unit, it is possible to select the baud rate (communication speed).

Gaining access to the DIP switches

- Power down the projector and unplug the power cord from the wall outlet.
- Turn both lock screws with a screwdriver or coin counter clockwise.
- Lift up and pivot the top cover. Attention : the cover is not secured with an incorporated support. When opening, turn it over slowly and lay it down on the second part of the top cover.
- The processor module with the DIP switches is located on top, the front left side (seen from the front of the projector, see next page).

Loosen the locking

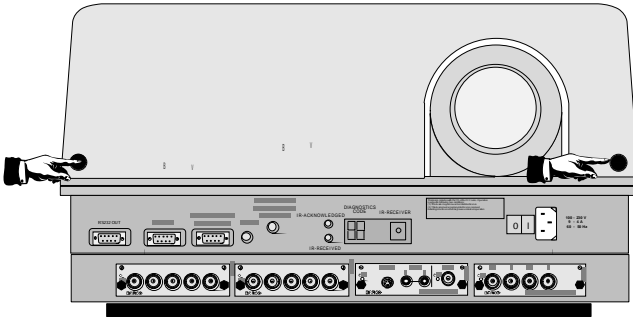

Open the top cover

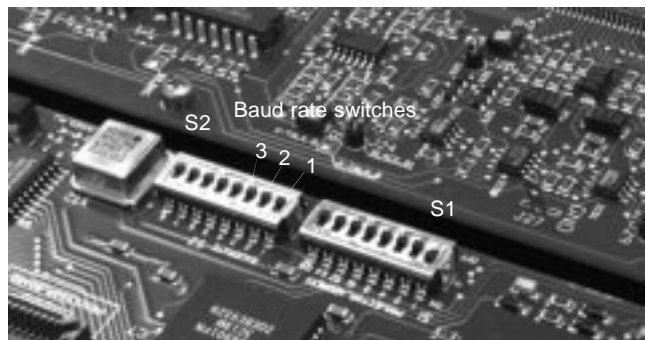
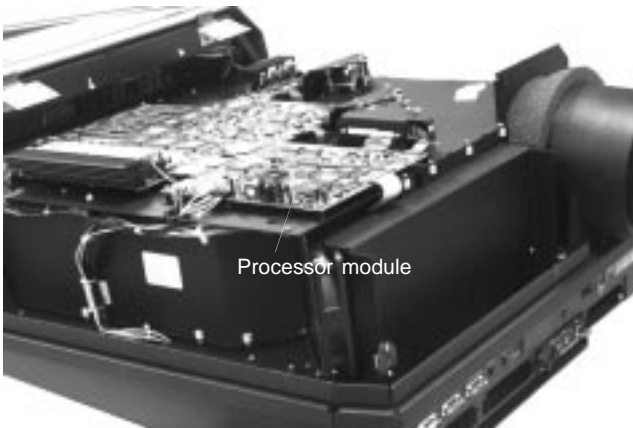
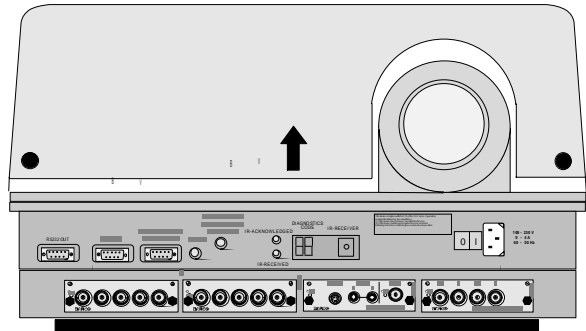

Baud rate setting

baud rate	S2/1	S2/2	S2/3
9600	OFF	OFF	OFF
4800	ON	OFF	OFF
2400	OFF	ON	OFF
1200	ON	ON	OFF
600	OFF	OFF	ON
300	ON	OFF	ON
150	OFF	ON	ON
75	ON	ON	ON

Change the position of the DIP switches with a small screwdriver.

If all switches are in the correct position, close the top cover and secure it by turning the lock screw clockwise. Connect the power cord to the wall outlet and switch on the projector.

**Connecting a RCVDS 05 to the projector.**

- Up to 10 inputs (20 when video inputs) with the RCVDS 05 and 90 inputs when RCVDS's are linked via the expansion module.
- Serial communication with the projector.
- Remote control buttons on the RCVDS to control the projector (source selection and analog settings).
- The selected source number will be displayed on a 2 digit display and the selected input module will be indicated with a LED on the rear.

For more information about the use of the RCVDS 05, consult the owner's manual, order number : R5975765.

**Connecting a VS05 to the projector**

The VS05 can switch up to 5 Composite Video sources, 3 Super Video sources and 1 RGB analog or component video source to the projector. In addition, the audio signal proper to the source, can be switched to an audio amplifier.

Order number : R9827890

For more information about the use of the VS05, consult the VS05 owner's manual, BARCO order number : R5975245.

**Connecting an IR Remote Receiver 800 to the projector.**

This infrared red receiver unit makes it possible to control the projector from another room.

There is a communication line cable between the IR receiver and the projector or the RCVDS. The control information from the RCU can now be sent to the IR Remote Receiver 800.

The IR Remote Receiver 800 displays the selected source on a 7-segment display.

Order number : R9827515.

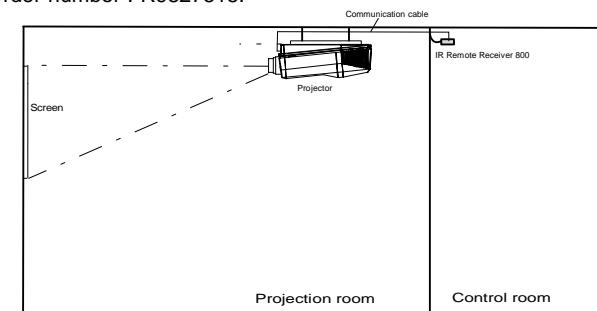

## 7

## CONTROLLING

The projector can be controlled with

- The RCU
- The hardwired RCU (cable is not included)
- The local keypad.

Controlling the projector with the RCU and the hardwired RCU is equal.

### How to use the RCU?

- Point the front of the RCU to the reflective screen surface.

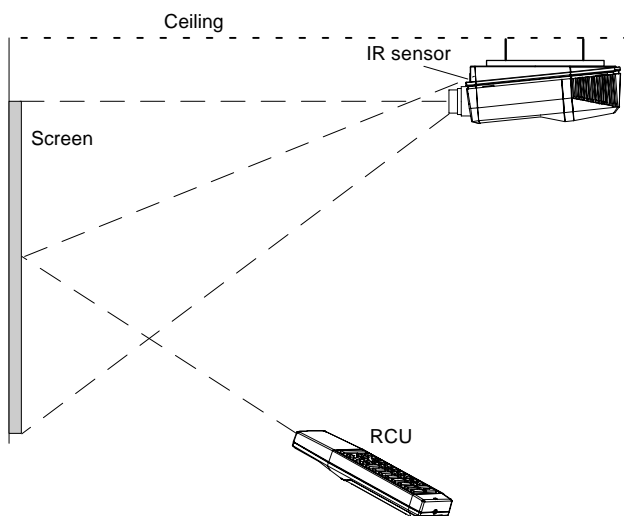

- RCU used in a hardwired configuration.

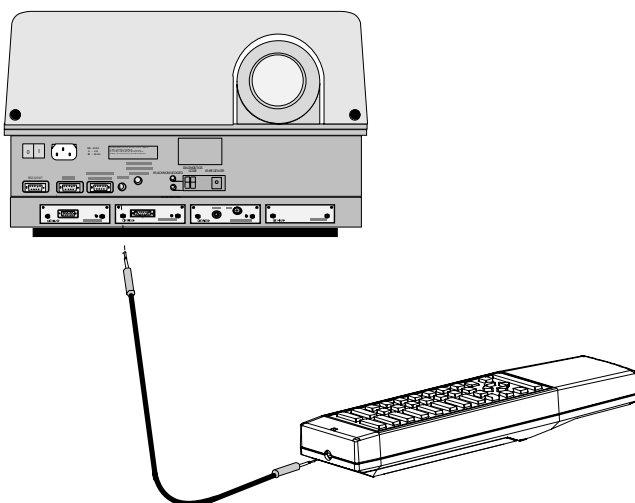

Plug one end of the remote cable in the connector on the bottom of the RCU and the second side in the connector in the front panel of the projector labelled 'REMOTE'.

- Point the front of the RCU directly at one of the IR sensors of the projector.

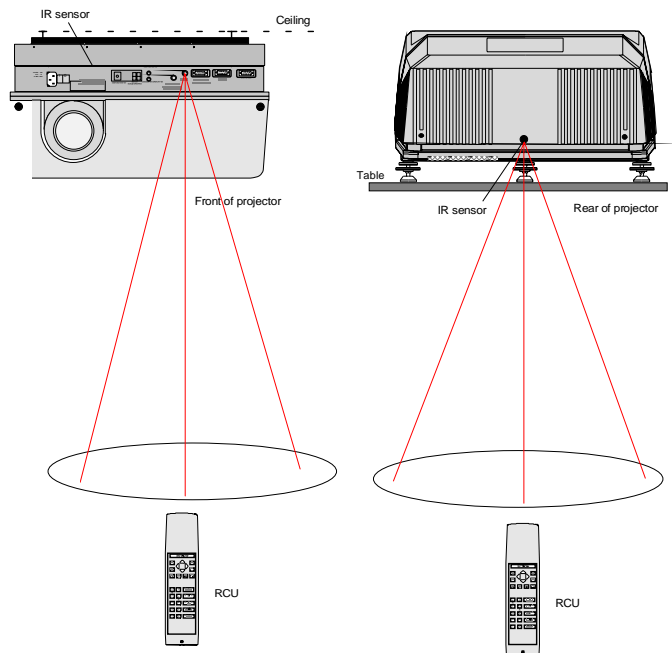

When using the wireless remote control, make sure you are within the effective operating distance (30m, 100ft in a straight line). The remote control unit will not function properly if strong light strikes the sensor window or if there are obstacles between the remote control unit and the projector IR sensor.

### Projector address

#### a. hardware set up of the projector address.

Every projector requires an individual address between 0 and 255 which is set with hardware DIP switches. To change that address, it is necessary to first open the top cover (see Gaining access to the DIP switches under Connecting to a computer.).

8 DIP switches (S1) are provided on the CPU module. Each DIP switch has its own decimal value (ON='1', OFF='0'). The summary of the values associated to those DIP switches gives the address

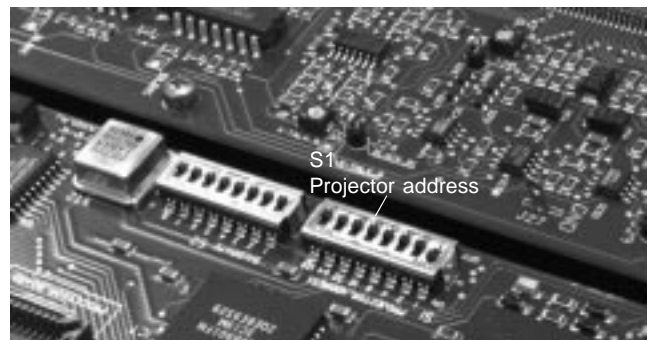

## Controlling

switch	value
1	1
2	2
3	4
4	8
5	16
6	32
7	64
8	128

Example : address 83

DIP switch	1	2	3	4	5	6	7	8
setting	1	1	0	0	1	0	1	0

Summary :  $1 \times 1 + 1 \times 2 + 0 \times 4 + 0 \times 8 + 1 \times 16 + 0 \times 32 + 1 \times 64 + 0 \times 128 = 83$

### b. How to control the projector or projectors.

The projector's address may be set to any value between 0 and 255. When the address is set, the projector can be controlled now :

- RCU for addresses between 0 and 9.
- computer, e.g. IBM PC (or compatible), Apple MAC, etc. for addresses between 0 and 255.

Note : A projector will respond to a RCU set to an address of '0' regardless of what address is set in the projector itself.

### c. Using the RCU.

Before using the RCU, it is necessary to enter the projector address into the RCU (only when that address is between 1 and 9). The projector with the corresponding address will listen to that specific RCU.

When address 0, 'zero address' is programmed into the RCU, every projector, without exception will listen to the commands given by this RCU.

### How to display a projector address?

Press the **ADDRESS** key (recessed key on the RCU) with a pencil. The projector's address will be displayed in a 'Text box'. This text box disappears after a few seconds. To continue using the RCU, it is necessary to enter the same address with the digit buttons (address between 0 and 9). For example : if the Address key displays projector address 003, then press "3" digit button on the RCU to set the RCU's address to match the projector's address. Do not press digit 003. This will address the remote to '0' and control all projectors in the room.

### How to program an address into the RCU?

Press the **ADDRESS** key (recessed key on the RCU) with a pencil and enter the address with the digit buttons. That address can be any digit between 0 and 9.

When programming '0', zero address, the RCU will control any projector regardless of the projector's address. This feature allows multiple projectors with different addresses to be controlled by a single RCU.

### Picture controls with direct access.

When an image control is pressed, a text box with a bar scale, icon and function name of the control, e.g. 'brightness...' appears on the screen (only if text is ON). See example screen. The length of the bar scale and the value of the numeric indication indicate the current memorized setting for this source. The bar scale changes as the + or - buttons of the control on the RCU are pressed or the + or - buttons on the local keypad.

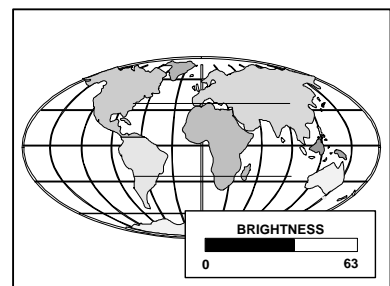
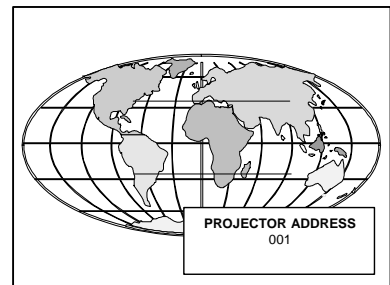

### Brightness Control

A correct '*brightness*' setting is important for good image reproduction.

Use the + button for a higher brightness.

Use the - button for a lower brightness.

### Contrast Control

A correct '*contrast*' setting is important for good image reproduction. Adjust the contrast to the level you prefer, according to room lighting conditions.

Use the + button for a higher contrast.

Use the - button for lower contrast.

### Color Saturation

Color saturation is only active for Video and S-Video. Adjust the color intensity of the picture.

Use the + button for richer colors.

Use the - button for lighter colors.

### Tint Control

Tint is only active for Video and S-Video when using the NTSC 4.43 or NTSC 3.58 system.

Use the + button

Use the - button.

### Sharpness Control.

Use the + button for a sharper picture.

Use the - button for a softer picture.

### Phase Control

Use the control stick to adjust the phase.

### How to get source information?

The projector can give information about its input configuration (inserted modules and 800 peripherals connection) in a menu box. To get this information, call the *Main* menu by pressing the **ENTER** key.

Highlight *System Settings* by pushing the control disk up or down and press **ENTER** to select this option. The System Settings menu will be displayed on the screen.

Highlight *Input Slots* by pushing the control disk up or down and press **ENTER** to select.

The projector's controller will scan the input slots and displays the result in the *Input Slots* menu.

Next to the digits you find the name of input slots. The controller starts counting from left to right when you are in front of the projector and looking to the lens.

If a RCVDS (switched on) or VS05 is connected to the projector, it will be also indicated on the menu by adding *+ 800 peripheral*. If no 800 peripheral indication is made on the menu, there are still two possibilities :

- no RCVDS or VS05 connected or
- RCVDS is switched off.

When a 800 peripheral is connected to the projector, the input slots are not accessible with the up or down arrow key to toggle their function.

If an input slot is empty, the indication *no module* is added next to the corresponding slot number in the *input slots* menu.

**EXIT** : returns to the System Settings menu.

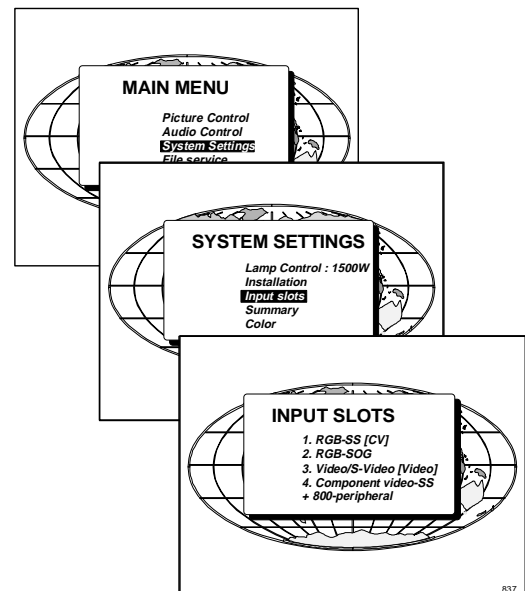

## How to get a summary of your projector?

The Summary gives an overview of :

- type of projector
- soft version
- lamp run time
- projector run time
- address
- installation configuration
- baud rate
- projector serial number
- lamp serial number

To display the Summary on the screen, press **ENTER** to start up the *Main* menu. Push the control disk up or down to highlight *System Settings* and press **ENTER** to display the *System Settings* menu.

Push the control disk up or down to highlight *Summary* and press **ENTER**. The summary will be displayed on the screen.

The following information is displayed :

- *type of projector* : BARCOVISION 8200

- *software version*

- *Address* : to change the address of the projector, see Projector Address above in this chapter.

- *Installation* : possible installations :

- \* Front/Ceiling
- \* Front/Table
- \* Rear/Ceiling
- \* Rear/Table

To change the installation configuration follow the instructions in chapter Installation Set Up.

- *Baud rate* : transfer speed for communication with a IBM PC (or compatible) or MAC. The baud rate of the projector must be the same as the baud rate of the connected computer. When there is a difference, consult Set up of the baud rate for communication with a computer in chapter Connections.

- *Projector Run Time* : gives the total run time since the first start up. All projectors leave the factory with a run time of approximately 24 hours.

- *lamp run time* : the total time the lamp has been used since it was installed in the projector.

**Attention** : the total lifetime of the lamp for a safe operation is 1000 hours maximum. Do not use it longer. Always replace the lamp with an original BARCO lamp kit.

- *Projector Serial number* : indicates the fabrication number of the projector. This number can be useful when calling for technical assistance.

- *Lamp Serial number* : indicates the fabrication number of the lamp. This number can be useful when calling for technical assistance.

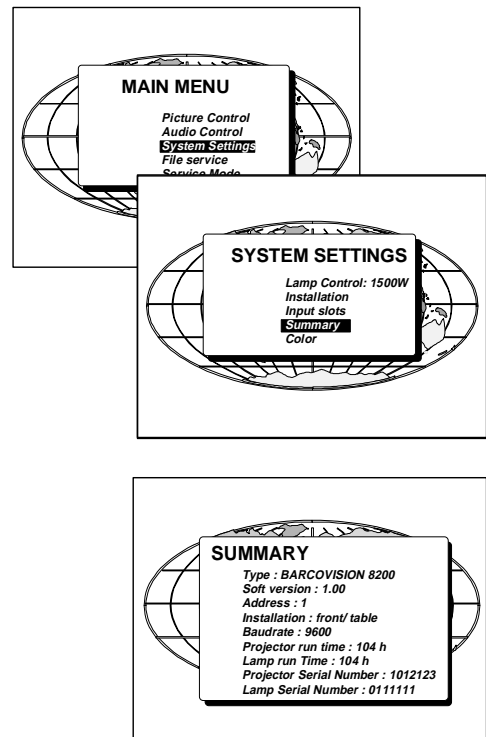

## 8

## SOURCE SET UP

## Input selection

Use the numeric keys on the RCU or use the local key pad to select the corresponding input slot.

The source settings has to be installed for each source when these sources are displayed for the first time.

## Installation of the settings for a input source.

Start up the adjustment mode by pressing **ENTER**. The main menu will be displayed. Push the joy stick key forward or backward to highlight File service.

*ENTER* selects the highlighted item and continues to the next step. *EXIT* returns always to the previous step.

\* Select the **LOAD** function to install the correct file. Only the files which can be used for this source will be shown. (See appendix A for a list of the standard available files).

File annotation :

xxxxxxx.xxx (Sx, xxxXxxx*i*)

*i* or blank : i = interlaced, blank = not interlaced

xxxXxxx : active pixel rating

Sx : source number

xxx : file extension, first character is C (for custom made files) or S (for standard files).

The second and third character is used for a following number (=file index)  
file index for custom files : 00 to 63.

xxxxxxx : base name, 8 characters.

The projector leaves the factory with different custom files installed.

Push the control disk up or down to select **LOAD** and press **ENTER** to display the Load menu.

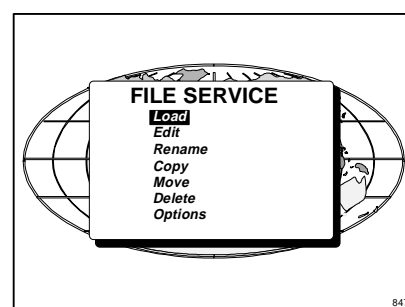
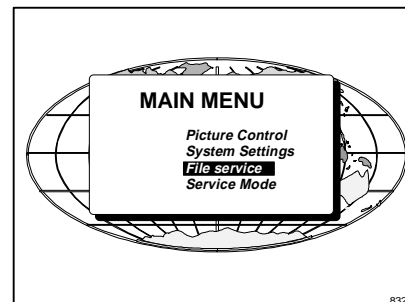

The Load menu displays the corresponding files depending on the installed search pattern. This search pattern can be "Fit" or "All". To change the search pattern, push the control disk to the right to select "search pattern" and press ENTER to change the annotation between brackets.

"All" : all available files will be displayed.

"Fit" : only the best fitting files will be displayed (with a distinction of  $\pm 2$  lines and line duration distinction of  $\pm 300$  ns)

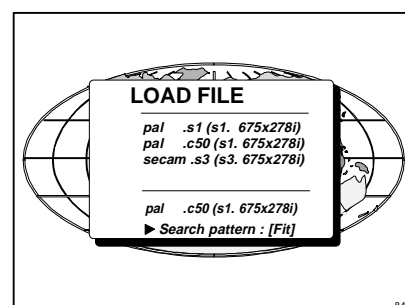

Push the control disk up or down to select the most fitting file and press **ENTER** to select. When scrolling through the files, the image will be adapted according the settings of the selected file (on line adaptation). When the best fitting image is displayed, press **ENTER** to select this file. A loading message with the selected file name will be displayed during the installation of the selected file.

If the displayed image is not yet as it has to be, select the most corresponding file and go to the Edit menu to change the file settings.

The actual active file is displayed on the second last line of the Load menu.

### Edit file

The Edit file menu makes it possible to change the settings of the file according to the real settings of the connected source. Consult the source specification before entering the VISION.

To start up the EDIT menu, push the control disk up or down to select EDIT in the FILE menu and press **ENTER**.

Select the file which must be edited (mostly the active file) and press **ENTER**.

The following selection menu will be displayed.

- Read only
- read/Write

*Read only* : the settings can be changed but will not be saved.

*Read/Write* : the settings are displayed and changes can be made and saved.

Push the control disk up or down to select and press **ENTER**.

The Edit file adaptation menu will be displayed.

The file name will be displayed in the upper right corner.

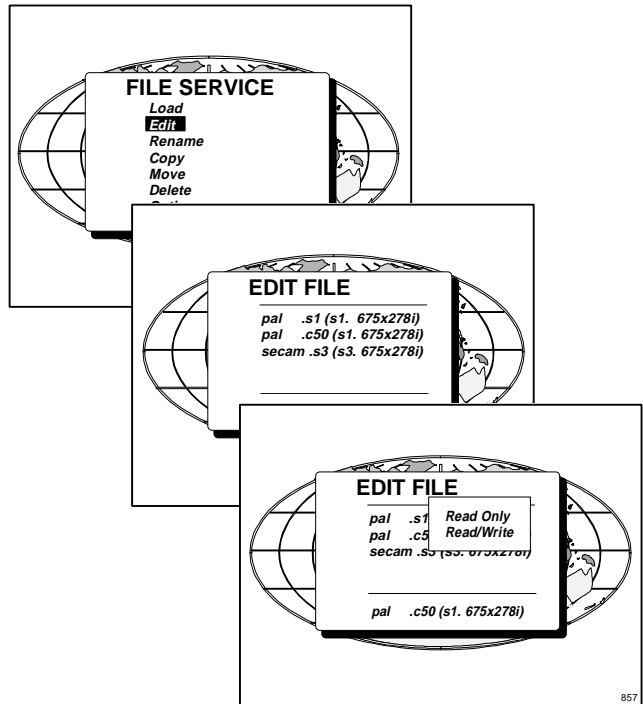

The following items can be adjusted :

- Total quantity horizontal pixels
- Active quantity horizontal pixels
- Horizontal shift in pixels
- Horizontal period in  $\mu$ s (is automatically adapted during the installation of a file with LOAD)
- Total vertical lines (is automatically adapted during the installation of a file with LOAD)
- Active vertical lines
- Vertical shift in lines
- Interlaced : toggle on/off (is automatically set to its correct position during the installation of a file with LOAD)

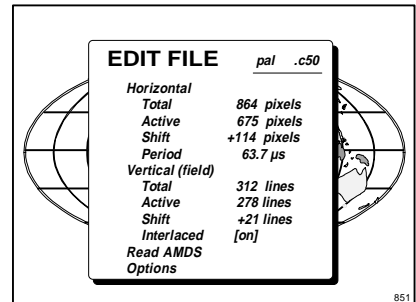

All settings can individually be changed (in video and S-video, horizontal total pixels cannot be changed). Push the control disk up or down to select an item. The color of the selected item will change and follow one of the three methods to change the value.

- a. press **ENTER** to activate the digits and enter directly with the numeric keys on the RCU or local keypad the new value or
- b. press **ENTER** to activate the digits. Push the control disk to the right or to the left to select the changing digit. Push the control disk up or down to scroll to desired digit. When finished press **ENTER** to confirm.
- c. counting up or down by pushing the control disk to the right or to the left.

To have a better view during an adjustment of the 'active' file, select "Horizontal" or "Vertical" by pushing the control disk up or down and press **ENTER**.

A full image is displayed with the settings on the left side.

To change the values, highlight (color change) first the changing value by pushing the control disk up or down and continue by pushing the control disk to the left or to right to count up or down.



How finding the correct values for the displayed item?

During the installation of a file with LOAD, the horizontal period, the total number of vertical lines and the interlaced mode are automatically measured and filled in in the menu table. These values will be available when starting up the EDIT procedure of an active file. Select first "Horizontal" and press **ENTER** to display a full image.

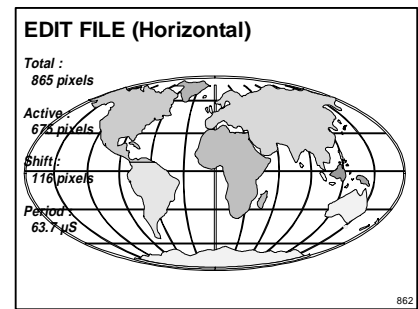

If the value for "Horizontal total pixels" is wrong, sampling mistakes (small vertical bars in the projected image) will be seen in the image. Select "Total" and adjust the pixel quantity. Adjust for zero bars (hint : if the number of bars increase, adjust in the other way).

The active pixels : determine the width of the window on the screen. This value is normally given in the source specifications. If not, adjust until full image is displayed (no missing pixels).

Horizontal shift : to shift the image on the screen.

Horizontal period : already filled in with the correct value when active file.

Press **EXIT** to return to the normal Edit file menu.

Select "Vertical" by pushing the control disk up or down and press **ENTER**. The full image is displayed.

The "Vertical Total lines" are already filled when an active file is selected to be edited.

The "Active lines" : number of horizontal lines determining the height of the projected image. This value is normally given in the specification of the source. If not, adjust until full image height is displayed (no missing lines)

Vertical shift : shift the image up and down (push joy stick forward or backward) on the screen until the correct image position is obtained.

Interlaced [On] or [Off] : this selection is automatically filled when active file has to be edited. If the image is wrong due to mismeasurement, use the ENTER key to toggle between [On] and [Off]. (for interlaced images, 1 frame contains 2 fields).

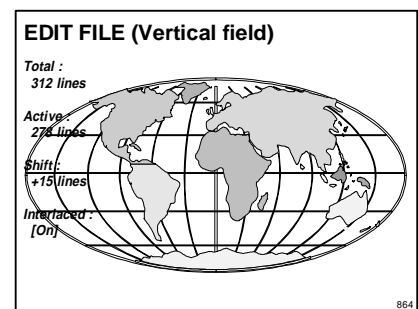
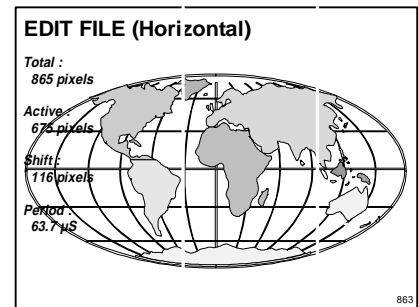

### Read AMDS

AMDS = automatic mode detection & synchronisation  
During the installation of a file with LOAD, the system measured automatically the horizontal period, the total vertical lines and the interlaced mode.

When selecting Read AMDS, the system remeasures the above indicated items.

### Options

Source number : The source number of a non-active source can be changed to any other source number. This makes it possible to create already a file for future source numbers.

Clamping : the clamping determines the black level of the signal.  
default setting : arrow up 1

Arrow up : trailing edge of the sync pulse to start the clamp pulse.

Arrow down : leading edge of the sync pulse to start the clamp pulse

1 : narrow clamp pulse

2 : wide clamp pulse

Field polarity inverted : default [No]

This function is used for interlaced images. Both rasters of the image could be shifted in a wrong way (double lines are visible in the image). This can be corrected by inverting the field polarity to [yes].

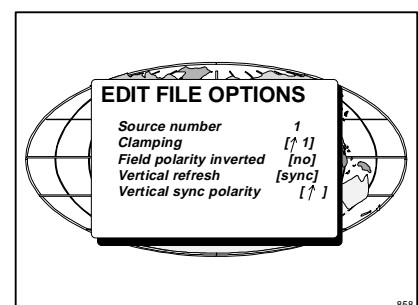

*Vertical refresh [sync/async]* : The way of updating the image information on the LCD panels.

\* For sources with a vertical frequency up to 60 Hz : the vertical refresh rate is the same as the vertical frequency of the incoming source. This is a necessity to project moving images without 'motion artefacts'. For stationary images with a vertical frequency up to 60 Hz it is still possible to use asynchronous refresh. When loading Pal, Secam, NTSC-files synchronous mode is default, for all other sources below 60 Hz asynchronous mode is default.

\* For sources with a vertical frequency higher than 60 Hz : the vertical refresh is different than the vertical frequency of the incoming source. Synchronous refresh cannot be used.

*Vertical sync polarity* : Vertical refresh can be synchronised with the leading sync edge [arrow down] or trailing sync edge [arrow up].

Press **EXIT** to leave the Edit File Option menu.

Press **EXIT** to leave the Edit menu. A confirmation menu will be displayed (only when the file is opened as "Read/Write").

"Save changes to file "filename.ext" ?

yes or no.

Use the control disk to select yes or no and press **ENTER**.

## Rename

To change the name of a selected file to the name given in the TO area.

Use the control disk to select **RENAME** and press **ENTER**. The rename menu will be displayed.

Use the control disk to select a file name in the left part of the menu and press **ENTER** to select. This file name will be written in the FROM area and the TO area. The TO area is active.

Press **ENTER** to select the separate characters. Push the control disk to the right or to the left to select the desired character. Change that character by pushing the control disk up or down. Numeric characters can be entered directly with numeric keys on the RCU.

Press **ENTER** to select Ok.

Press **ENTER** for OK. The renamed file is entered in the list of files. Press **EXIT** to leave the Rename menu.

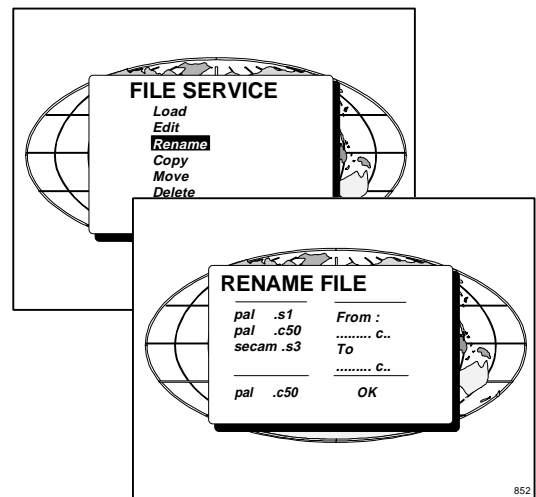

## Copy

To copy a selected file to the file with the name and extension given in the TO area.

Use the control disk to select **COPY** and press **ENTER**. The copy menu will be displayed.

Use the control disk to select a file in the list of files in the left part of the menu and press **ENTER** to select. This file name will be written in the FROM area and the base name of the selected file in the TO area. The file index in the TO area will be an unused file index. The TO area becomes active. Press **ENTER** to select the separate characters. Push the control disk to the right or to the left to select the desired character. Change that character by pushing the control disk up or down (digits can be entered directly using the numeric keys).

Press **ENTER** to select Ok.

Press **ENTER** for OK. The copied file is entered in the list of files.

Press **EXIT** to leave the Copy menu (note : if the file index is changed to an existing index, a confirmation menu will be displayed).

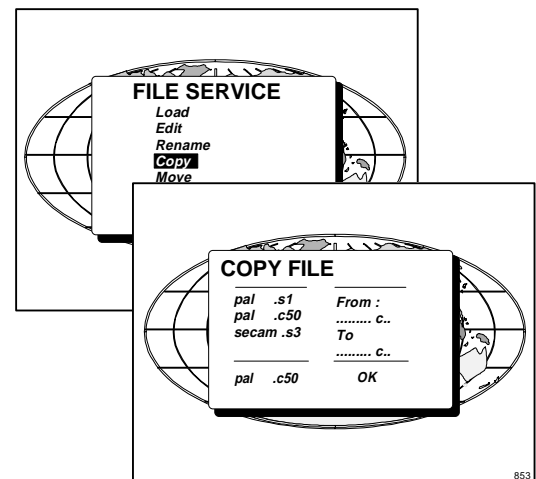

## Move

To move a selected file to the file with the name and extension given in the TO area.

Use the control disk to select MOVE and press **ENTER**. The move menu will be displayed.

Use the control disk to select a file in the list of files in the left part of the menu and press **ENTER** to select. The selected file will be written in the FROM area and the base name in the TO area. The file index in the TO area will be an unused index. The TO area becomes active. Press **ENTER** to select the separate characters. Push the control disk to the left or to the right to select the desired character. Change that characters by pushing the control disk up or down (digits can be changed directly with the numeric keys).

Press **ENTER** to select Ok.

Press **ENTER** for OK. The moved file is entered in the list of files (note: if the file index is changed to an existing index, a confirmation menu will be displayed).

Press EXIT to leave the move menu.

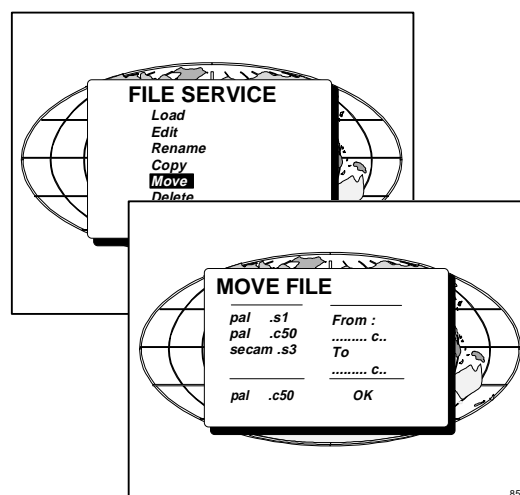

## Delete

To delete a selected file out of the list of files.

Use the control disk to select DELETE and press **ENTER**. The delete menu will be displayed.

Push the control disk up or down to select a file and press **ENTER**. The selected file is written in the Delete area and the OK button is active. Press **ENTER** to delete the file.

A confirmation menu "Delete file 'file name'?" is displayed. When you want to delete the file, select Yes by pushing the control disk to the left or to the right and press **ENTER**. If you do not want to delete the file, select No and press **ENTER**.

Note : the active file cannot be deleted.

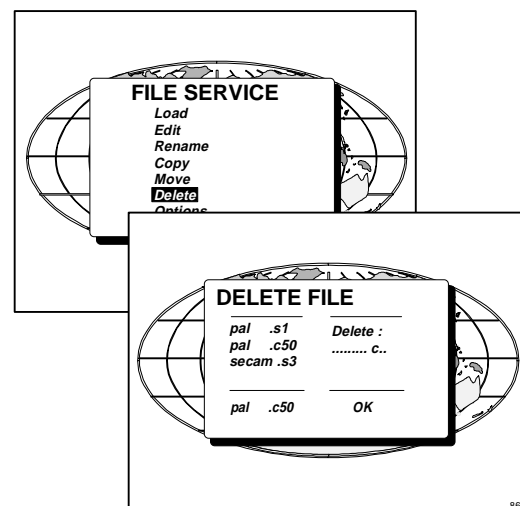

## Options

Use the control disk to select OPTIONS and press **ENTER**. The Options menu will be displayed.

The list of files can be given only by name and extension (file details OFF) or with full details (file details ON).

example :

file details [Off] pal .c50

file details [On]

pal .c50 (S1. 675x278i)

The list of files in the different File menus can be sorted by file name (file sort [name]) or by file extension (file sort [index]).

Select the options by pushing the control disk up or down and press **ENTER** to toggle the option.

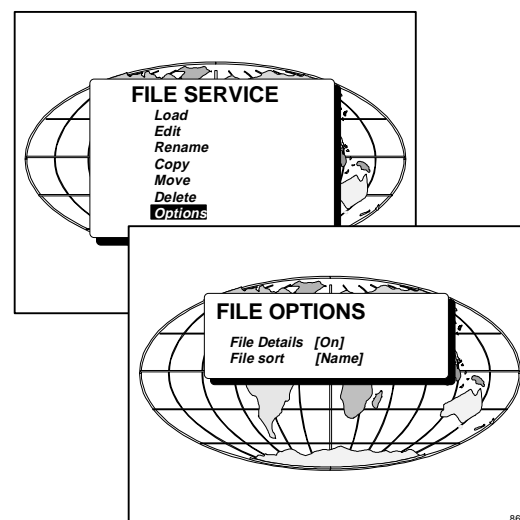



## 9

## PICTURE CONTROL IN ADJUSTMENT MODE

The picture control menu is split up in two parts :

Signal operations  
and  
Screen operations.

*Signal operations* : to manipulate the video signal, e.g. sync slow/fast, color balance adjustment etc.

*Screen operations* : to manipulate the projection window and the picture, e.g. shift, stretch, enlarge and reduce.

### Signal operations.

Select first the Picture Control menu on the Main menu by pushing the control disk up or down.  
Press **ENTER** to select.

Push the control disk up or down to select Signal Operations.

The default setting for all items are shown in the menu next to this text.  
To change a value in the Signal Operation menu, select first the item by pushing the control disk up or down and follow then one of the two following methods :

- direct access, with the numeric keys on the RCU or local keypad.
- scrolling by pushing the control disk to the right or to the left until the desired value (image quality) is obtained.

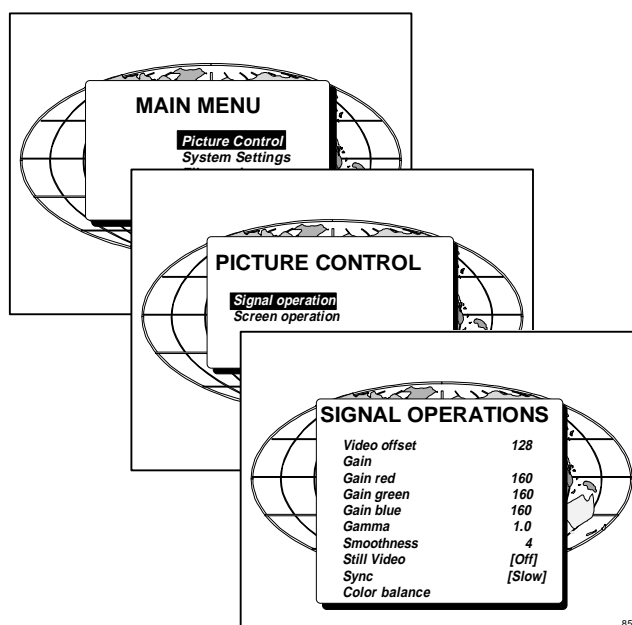

### Video offset

Default value : 128

To adjust the Video offset, be sure the contrast level is adjusted to "48" (brightness setting has no influence) and the color saturation is set to zero (for video). When possible use a grey scale test pattern. Adjust until the second last bar (dark grey) is distinguishable from the last bar (black).

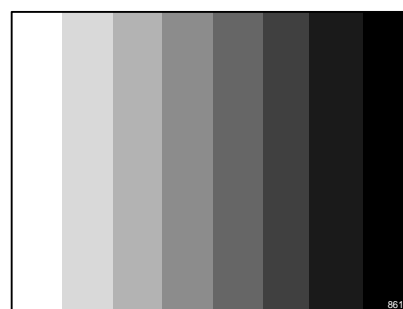

### Gain

Default value : 160

To adjust the Gain, be sure the contrast level is adjusted to "48".  
When possible use a grey scale test pattern. Adjust until the first white bar is distinguishable from the second white bar.

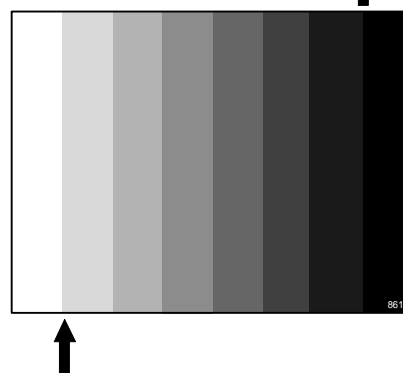

### Gain adjustment per color

If the obtained color balance is not yet correct, adjust with the separate gain controls until the desired color balance is obtained.

### Smoothness

The lower the smoothness value, the sharper the image. The influence of this setting is visible on high density image with small characters.

### Still video [On/Off]

This function is only used for stationary interlaced images. Highlight Still Video by pushing the control stick forward or backward and press **ENTER** to toggle between ON and OFF. Still Video [On] : the displayed image contains less jitter and gives a sharper image. Still Video [Off] : for moving pictures.

### Sync [Fast/Slow]

Highlight Sync by pushing the control disk up or down and press **ENTER** to toggle between Slow and Fast.

Note : Sync is normally used in the SLOW position. The FAST position is used to compensate for unsteady sync pulses from older video playback equipment.

### Color Balance

Highlight Color Balance by pushing the control disk up or down and press **ENTER** to select the color balance selection menu. The next choices are possible :  
 3200K  
 6500K  
 9500K  
 Custom  
 Use the control disk to make your selection and press **ENTER**. A marker indicates the actual color balance setting.

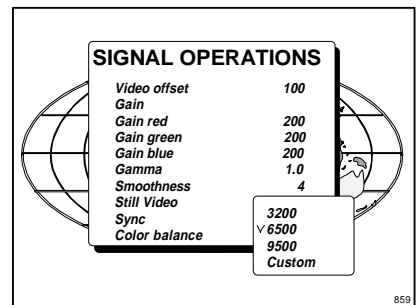

When custom is selected, the blue and red color can be adjusted (range from 0 to 2.5) in comparison with the green color (value 1). Push the control disk up or down to select blue or red. Push the control disk to the left or to the right to adjust.

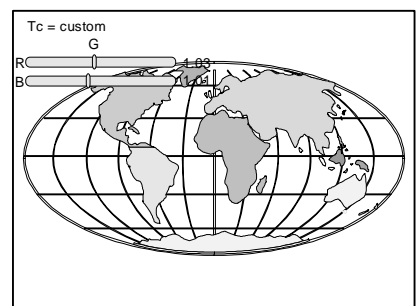

### Screen operations

Select the *Picture Control* menu on the Main menu by pushing the control disk up or down. Press **ENTER** to select. Push the control disk up or down to select *Screen operations*. Press **ENTER** to select.

When pushing continuously on the control disk, the adjustment will be executed in an accelerated fashion.

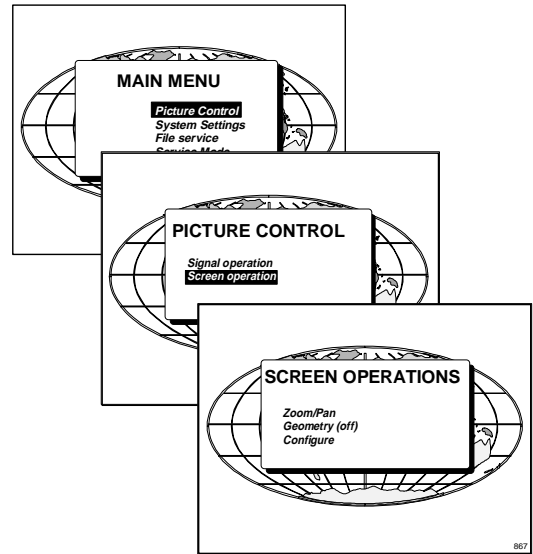

### Zoom/pan

Push the control disk up or down to highlight *Zoom/Pan* and press **ENTER** to select.

All functions, e.g. move, enlarge, reduce, stretch, can be done on a "Window" or on a "Picture".

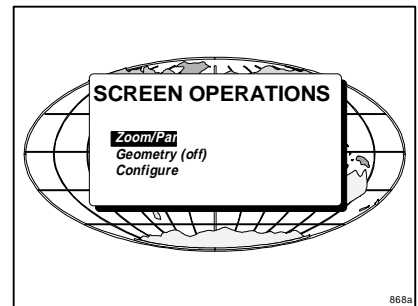

### Window

A window determines the maximum area used on the screen to project a picture.

This window can be placed in any position on the screen using the move, reduce and stretch controls. During a first start up, the window will be on its maximum dimensions. Enlarging and moving is not possible in this maximum position.

Use the following controls to create a desired window on the screen. With these functions, all aspect ratios are possible.

Select the controls by pushing the control disk to the right or to the left and press **ENTER** to activate the control.

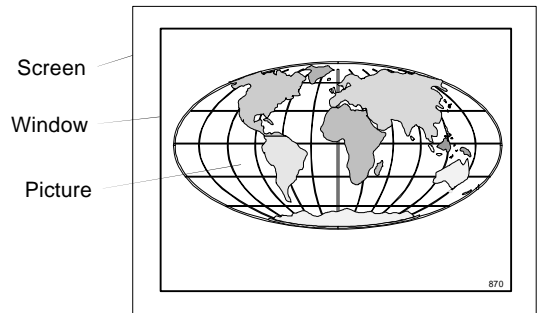

moves the window to the left.

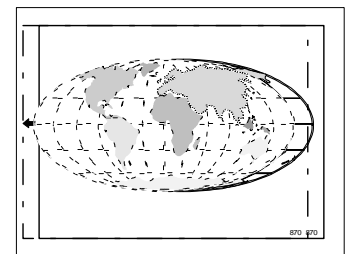

moves the window to the right.

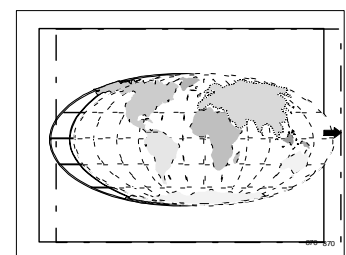

[window] ◀▶ ▲▼ ◀▶▶ ▶▶▶ ◆◆◆ ⚡ ◆◆◆ ⚡◆◆◆ ⚡◆◆◆

▲ moves the window upwards

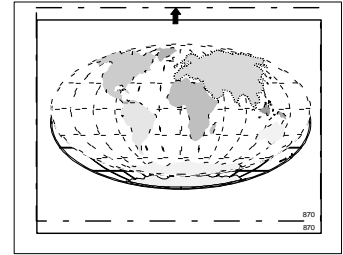

[window] ◀▶ ▲▼ ◀▶▶ ▶▶▶ ◆◆◆ ⚡ ◆◆◆ ⚡◆◆◆

▼ moves the window downwards

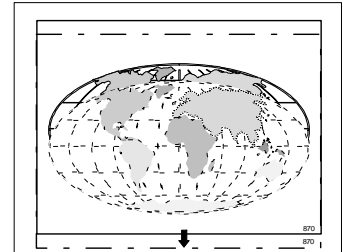

[window] ◀▶ ▲▼ ◀▶▶ ▶▶▶ ◆◆◆ ⚡ ◆◆◆ ⚡◆◆◆

◀▶ stretches the window in the horizontal direction.

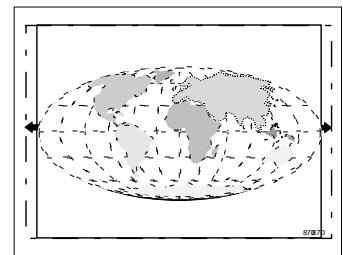

[window] ◀▶ ▲▼ ◀▶▶ ▶▶▶ ◆◆◆ ⚡ ◆◆◆ ⚡◆◆◆

▶▶ compresses the window in the horizontal direction.

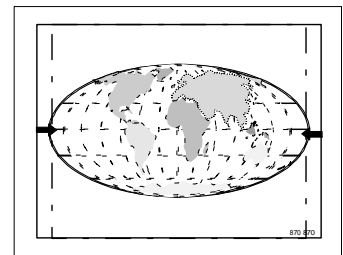

[window] ◀▶ ▲▼ ◀▶▶ ▶▶▶ ◆◆◆ ⚡ ◆◆◆ ⚡◆◆◆

◆◆◆ stretches the window in the vertical direction.

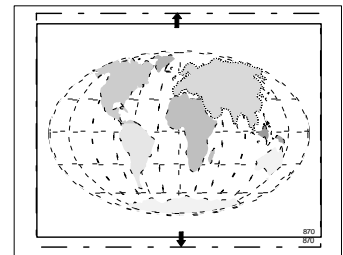

[window] ◀▶ ▲▼ ◀▶▶ ▶▶▶ ◆◆◆ ⚡ ◆◆◆ ⚡◆◆◆

◆◆◆ compresses the windows in the vertical direction.

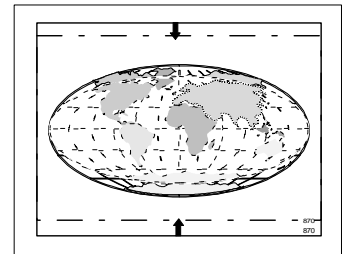

[window] ◀▶ ▲▼ ◀▶▶ ▶▶▶ ◆◆◆ ⚡ ◆◆◆ ⚡◆◆◆

◆◆◆ enlarges the window, both of horizontal and vertical directions simultaneously.

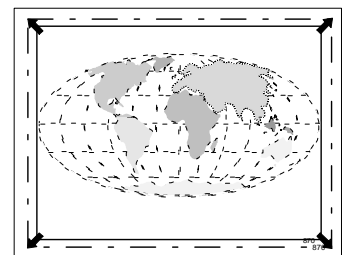



[window] ◀▶ ▲▼ ◆◀▶ ◆▶ ◆◻ ◆◼ ◻◻



reduces the window, both of horizontal and vertical directions simultaneously.

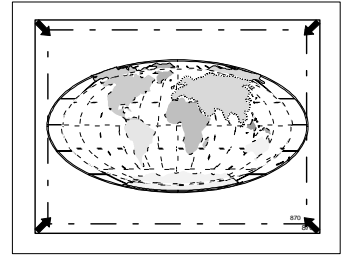

[window] ◀▶ ▲▼ ◆◀▶ ◆▶ ◆◻ ◆◼ ◻◻

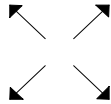

reset button, brings the window to its maximum dimensions.

Picture

The picture can be moved, enlarged, reduced within a created window.

[picture] ◀▶ ◻◻ ▲▼ ◆◀▶ ◆▶ ◆◻ ◆◼ ◻◻



Displays the covered info on the left side.  
(you have to consider that you are moving your camera to the left side).

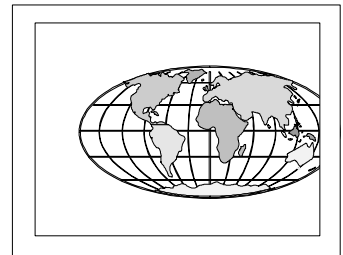

[picture] ◀▶ ◻◻ ▲▼ ◆◀▶ ◆▶ ◆◻ ◆◼ ◻◻



Displays the covered info on the right side.

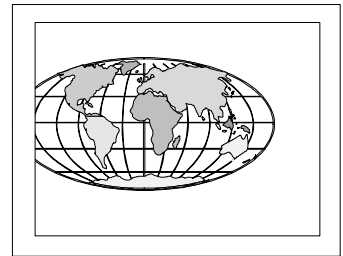

[picture] ◀▶ ◻◻ ▲▼ ◆◀▶ ◆▶ ◆◻ ◆◼ ◻◻



Displays the covered info on the top side .

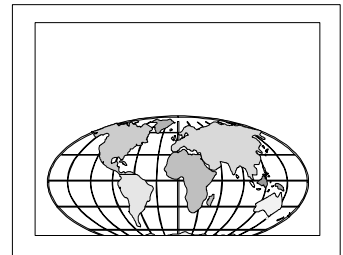

[picture] ◀▶ ◻◻ ▲▼ ◆◀▶ ◆▶ ◆◻ ◆◼ ◻◻



Displays the covered info on the bottom side.

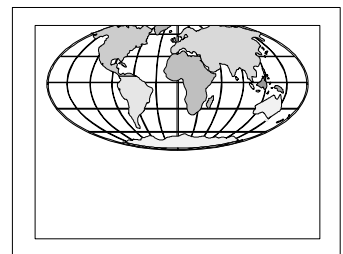

[picture] ◀▶ ◻◻ ▲▼ ◆◀▶ ◆▶ ◆◻ ◆◼ ◻◻



Stretches the picture in the horizontal direction.

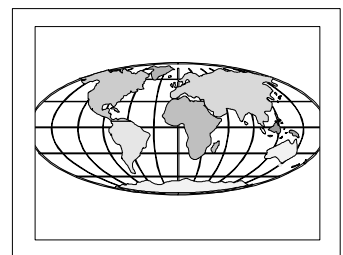



## Configure

The configure menu contains two toggle functions : *geometry* and *conversion*.

Use the control disk to select *Configure* and press **ENTER**.

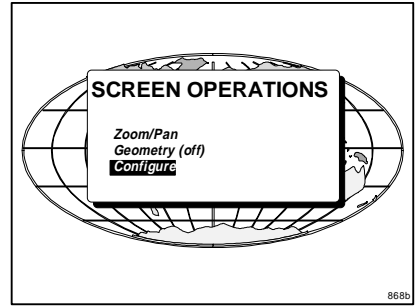

## Conversion

All incoming signals are internally converted to be displayed at its maximum possible dimensions. When conversion is [off], the real input signal is displayed on the screen. Parts of the image cannot be displayed and will be lost.

When conversion is [off], the geometry function is disabled.

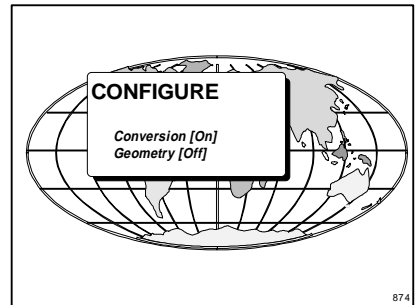

## Geometry

The Geometry function can only be activated when conversion is [on].

Use the Geometry adjustment to align the image if the projector is mounted under a non standard projection angle.

If the Geometry function has to be adjusted, toggle Geometry to [On] with the **ENTER** key and press **EXIT** to return to the *Screen Operations* menu (previous menu).

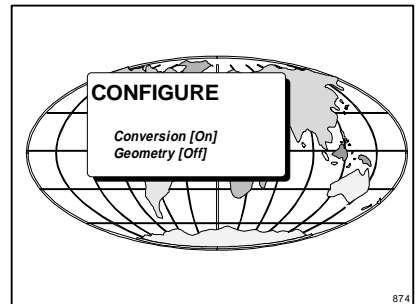

Highlight *Geometry* and press **ENTER** to select. The geometry menu will be displayed.

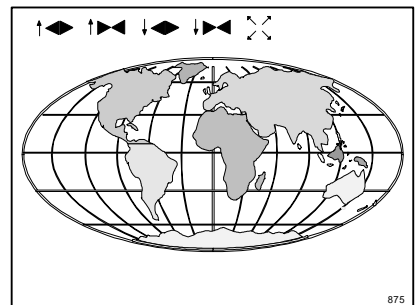
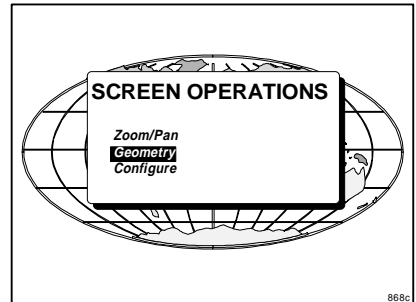



Enlarge the upper part of the projected image in horizontal way.

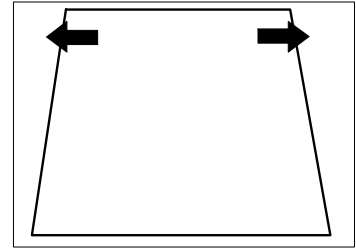

Reduce the upper part of the projected image in horizontal way.

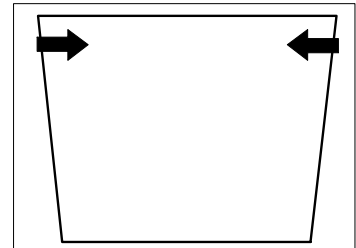

Enlarge the lower part of the projected image in horizontal way.

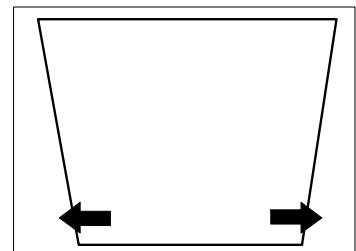

Reduce the lower part of the projected image in horizontal way.

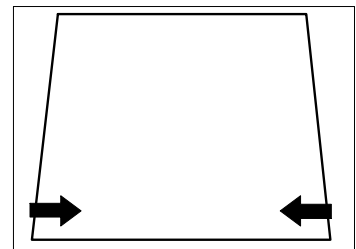

Reset, brings the image to a squared image without distortion.

# 10 SERVICE MODE

The service mode offers :

- test patterns such as convergence patterns (green, red on green, blue on green and hatch patterns).
- alignments for the decoder circuit such as luminance delay, comb filter, etc. (more info in service manual)
- modifying password
- resetting the lamp run time.
- lamp run time history.
- I<sup>2</sup>C Device test (more info in service manual)

To protect your settings made in the service mode, a password can be introduced. When the password function is activated, every time the Service mode is selected, the service mode asks for your password before continuing.

## How to activate the password function?

The password function can be hardware set with a DIP switch on the CPU module. To change the position of this DIP switch, it is necessary to open first the top cover (see Set up of the baud rate for communication with a computer, chapter Connections).

When DIP switch 4 (S2) is in the :

- ON position, password is activated.
- OFF position, password not activated, service mode is free accessible.

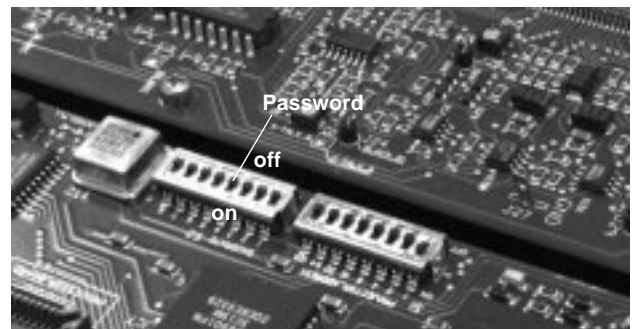

## Start up of the Service mode.

When in operational mode, press **ENTER** to display the *main* menu. Use the control disk to highlight *Service mode* and press **ENTER**.

If the password function is activated, the *Enter password* box appears on the screen.

Your password contains 4 digits. Enter the digits with the numeric keys on the RCU or the local keypad.

Example : 2 3 1 9

For each digit entered, a 'X' appears on the screen under the displayed text '*Enter password*'

When the entered password is wrong, the following message will be displayed : *Invalid Password*.

Press **EXIT** to return to the main menu.

When your password is correct, you gain access to the Service menu.

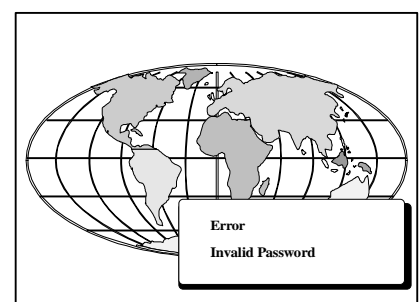
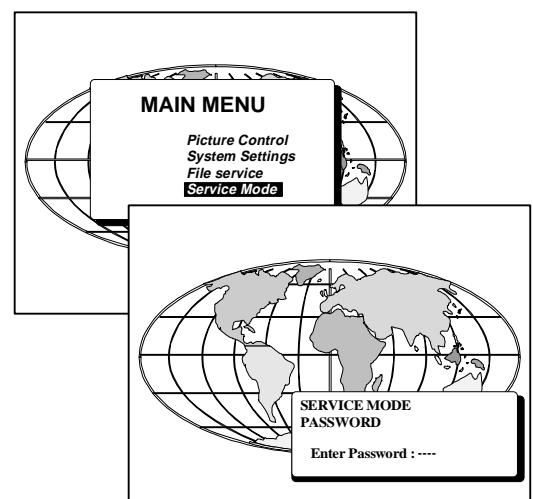

## Service Mode

Factory programmed password :

**0000**

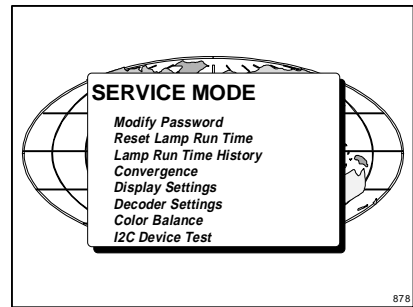

### Convergence adjustment of the LCD panels.

Every LCD panel has 6 adjustment screws. By turning these screws you change the relative position of the panels and converge the image.

Always start with the adjustment of the green panel. When the green image is correctly focused, it will later on be used as the reference image to converge the red and blue image.

Next alignments have to be done :

You have to adjust the green panel until the indicated lines on the screen are focused (sharp lines). Continue with the red panel and adjust until the red lines coincide with the green lines. Then continue with the blue panel until the blue lines coincide with the green lines.

Follow the next procedure to adjust the LCD panels.

\* Open the top cover as described in *Gaining access to the DIP switches* under *Connecting to a computer* in chapter *Connections*.

The three mounting parts for the LCD's (two are shown on the drawing below) are located on the black metal cover. The screws are indicated from 1 to 6 for each color.

Note : the space between the LCD panel in the green channel and the field lens has to be 4 to 5 mm. Otherwise when projecting a black image, a discoloring will be visible. (To project a black image, select the internal pattern 'purity' and put all settings to '0')

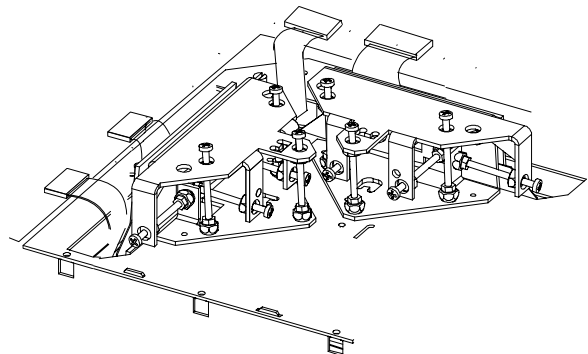

To adjust the convergence, there are test patterns provided in the service menu.

Use the control disk to highlight *Convergence* and press **ENTER** to display the *Convergence* menu. Start with the Green test pattern and continue with the Red on green and finish with the Blue on green.

Use the control disk to select *Green* and press **ENTER** to display the green pattern.

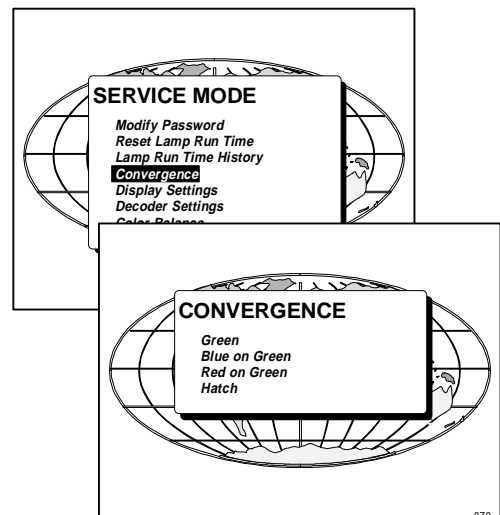

The pattern shows lines of one pixel.

Near six lines on the displayed pattern, a screw is drawn with a number next to it (e.g. if displayed in green = corresponding with the screws and numbers on the green LCD panel).

When turning a screw in the direction marked by the arrow above the displayed screw on the screen, the line on the screen moves in the direction of the straight arrow.

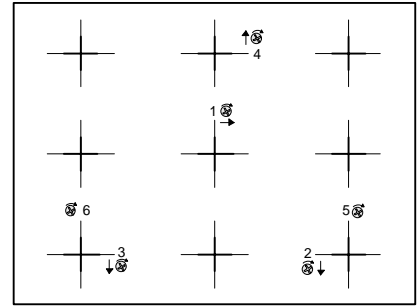

### Green focusing

- Adjust the projection lens until optimum focus for the lines 5 and 6 is obtained.
- Turn screw 4 for optimum focus of the corresponding green line 4 on the screen.
- Turn screw 5 for optimum focus of the corresponding green line 5 on the screen.
- Turn screw 6 for optimum focus of the corresponding green line 6 on the screen.

The three alignments influence each other, therefore repeat if necessary the above three steps (b,c and d).

When the green pattern is correctly focused, press **EXIT** to return to the *Test pattern* menu.

### Red on green convergence.

Use the control disk to highlight *Red on green* and press **ENTER** to display the Red on green test pattern.

The longest lines are the red lines. These lines must be converged with the green lines.

The drawn screws and numbers are displayed in red.

Follow next steps :

- Adjust first screws 4, 5 and 6 to obtain an optimum focus for respective lines 4, 5 and 6.

Due to interaction, it may be necessary to repeat step a several times.

Follow next steps to converge the red lines with the green lines :

- Start with screw 2 and adjust for optimal convergence of line 2.
- Adjust screw 3 for optimal convergence of line 3.

Due to interaction repeat above two steps (b and c) if line 2 and possibly line 3 is misaligned.

If both lines are correctly converged, continue with screw 4.

Adjust screw 4 until line 4 is correctly converged. It is possible that line 2 and 3 have to be reconverged. If so, repeat procedure for screw 2 and 3 (step b and c)

If line 2, 3 and 4 are converged, continue with line 1 (screw 1).

When line 1 is converged, check again the convergence of lines 2, 3 and 4. If necessary repeat the above procedure for the corresponding lines.

Check if lines 5 and 6 are correctly converged. If so, press **EXIT** to return to the *Test pattern* menu and continue with Blue on green.

If not yet correctly converged, check the distance between lines 5 and 6 of the red pattern and the distance between lines 5 and 6 of the green lines.

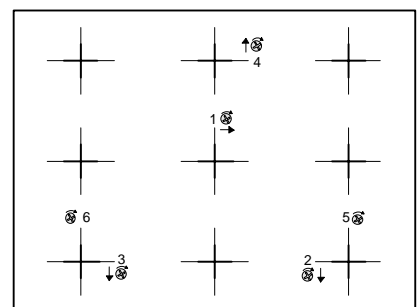
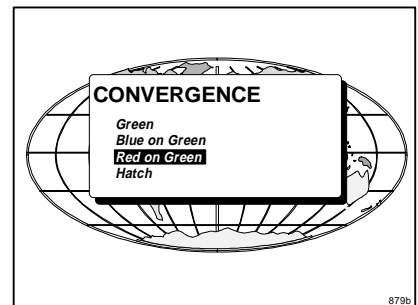
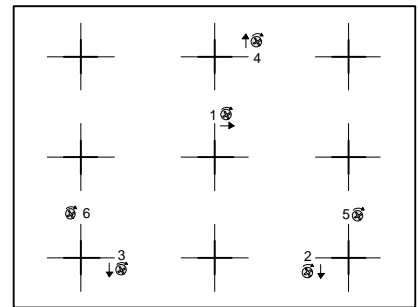

## Service Mode

Two possibilities :

- 1) distance between red lines is smaller than distance between green lines.  
Turn screw 5 and 6 clockwise until distance between lines 5 and 6 is the same for the red and green lines.
- 2) distance between red lines is greater than distance between green lines.  
Turn screw 5 and 6 counter clockwise until distance between lines 5 and 6 is the same for the red and green lines.

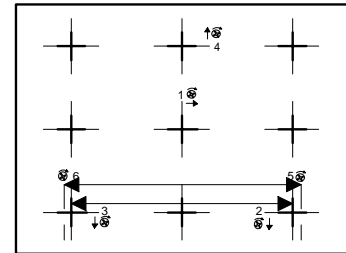
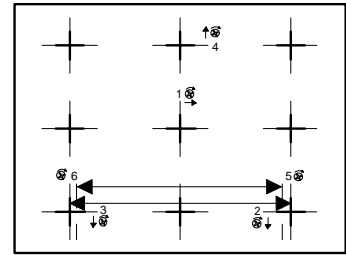

Due to this movement the lines 1, 2, 3 and 4 may be out of convergence. Repeat the above mentioned steps for the respective lines.

If all lines are correctly converged, press **EXIT** to return to the *Test pattern* menu.

### Blue on green convergence.

Use the control disk to highlight *Blue on green* and press **ENTER** to display the Blue on green test pattern.

Repeat the same procedure as for Red on green lines but read blue when red is indicated.

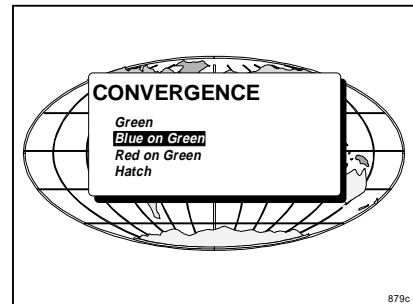

To check the result of the convergence adjustments, highlight *Hatch* and press **ENTER**. A hatch pattern will be displayed on the screen.

**ENTER** : displays a hatch pattern.  
**EXIT** : returns to the service menu.

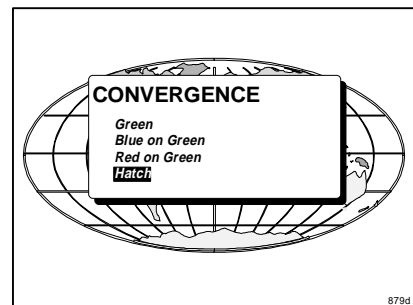

All lines must be displayed in white, if not so repeat the convergence adjustment procedure.

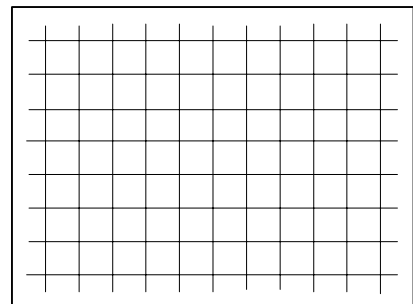



## Modify password

To change your password, highlight *Modify password* and press **ENTER** to start up the password modification procedure. Enter your old password with the digit keys. After the fourth digit is entered, the next modify password menu is displayed.

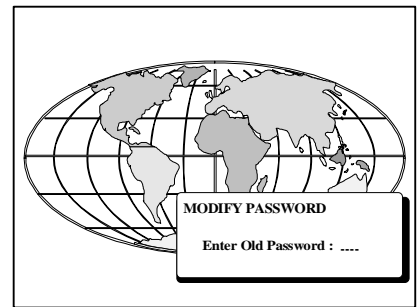

Your new password will be asked if your old password is correct. Enter your new password with the digit keys. After the fourth digit, the projector will ask to re-enter your new password.

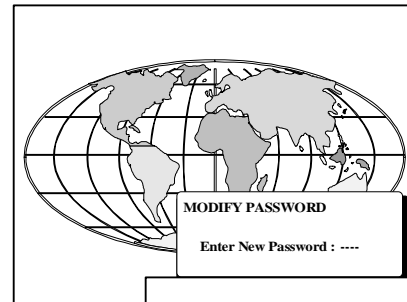

Re-enter your new password.

When the password is correct, the message "Password modified" will be displayed for a certain time and then the projector returns to the Service menu.

When the password is not correct, an error message "Invalid password" will be displayed. Press **EXIT** to continue. The projector returns to the Service menu without changing the password.

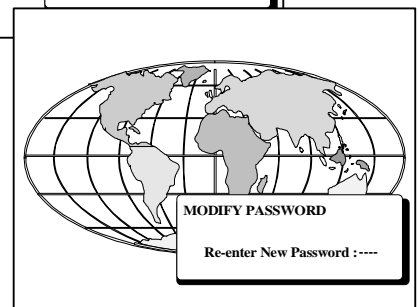

## Lamp Run Time History

To get an overview of the different lamp run times, highlight *Lamp Run Time History* and press **ENTER**. A listing with the lamp serial number and the corresponding run time will be displayed.

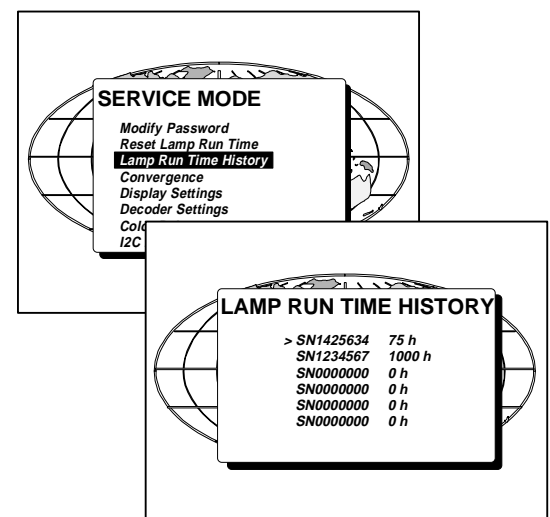

## Reset Lamp Run Time.

Highlight *Reset Lamp Run Time* and press **ENTER** to select.

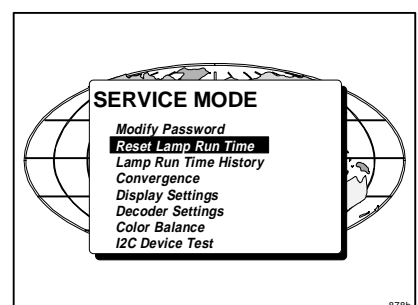

## Service Mode

---

When *Reset Lamp Run Time* is selected in the *Service Mode* menu, the following warning will be displayed :  
Risk of electrical shock. Reset lamp run time is reserved to qualified service personnel.  
If you are not qualified, press **EXIT** to cancel the reset operation.

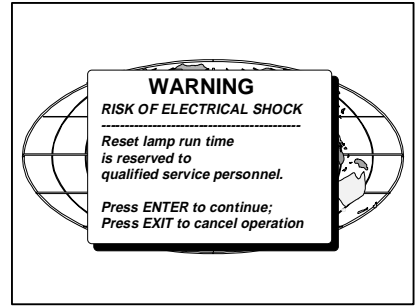

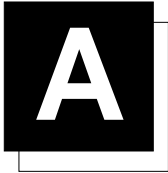

# STANDARD SOURCE SET UP FILES

## Standard source set up files.

Standard preprogrammed set up files.

NAME	RESOLUTION	FVERT Hz	FHOR kHz	FPIX MHz	PTOT	PACT	LTOT	LACT
CGA	640 X 200	59,924	15,700	14,318	912	640	262	200
NTSC	675 X 240I	29,970	15,734	13,500	858	675	263	240
NTSC_2	675 X 240I	29,970	15,734	13,500	858	675	263	240
PAL	675 X 278I	25,000	15,625	13,500	864	675	313	278
PAL_2	675 X 278I	25,000	15,625	13,500	864	675	313	278
SECAM	675 X 278I	25,000	15,625	13,500	864	675	313	278
SECAM_2	675 X 278I	25,000	15,625	13,500	864	675	313	278
EGA	640 X 350	59,702	21,851	16,257	744	640	366	350
MAC_5	512 X 342	60,158	22,259	15,670	704	512	370	342
MAC_3	512 X 384	60,147	24,480	15,667	640	512	407	384
MAC_4	560 X 384	60,147	24,480	17,234	704	560	407	384
8514-A	1024 X 384I	43,479	35,522	44,900	1264	1024	409	384
VGA_TXT	720 X 400	70,087	31,469	28,322	900	720	449	400
COMPUSC4	1024 X 480I	29,945	30,694	39,779	1296	1024	512	480
VGA_72V	640 X 480	72,800	37,856	31,496	832	640	520	480
VGA_GR	640 X 480	59,941	31,469	25,175	800	640	525	480
VGA75ISO	640 X 480	75,000	39,375	31,500	800	640	525	480
MAC_2	640 X 480	66,667	35,000	30,240	864	640	525	480
MAC_LC	640 X 480	66,619	34,975	31,338	896	640	525	480
MUSE	960 X 518I	30,000	33,750	37,125	1100	960	563	518
HDMAC	1008 X 570I	25,020	31,250	39,125	1252	1008	625	570
SVGA_56V(*)	800 X 600	56,250	35,156	36,000	1024	800	625	600
SVGA_60V(*)	800 X 600	60,317	37,879	40,000	1056	800	628	600
SVGA_72V(*)	800 X 600	72,084	48,080	50,003	1040	800	667	600

*Name* : name of file, contains the settings  
Resolution : image resolution, when followed by ...I means interlaced.

*FVERTHz* : vertical frequency of the source

*FHOR kHz* : horizontal frequency of the source.

*FPIX MHz* : pixel frequency

*PTOT* : total pixels on one horizontal line

*PACT* : active pixels on one horizontal line

*LTOT* : total lines in one frame

*LACT* : active lines in one frame

(\*) This source type will be displayed in a window of 756 x 756 pixels, no conversion.



# B

## BATTERY REPLACEMENT IN THE RCU

### Battery replacement in the RCU.

Remove the battery cover on the backside of the remote control by pushing the indicated handle a little to the bottom of the RCU. Lift up the top side of the cover at the same time. (fig. 1)

Remove the battery from the compartment and disconnect the contact plate. (fig. 2)  
Connect a new 9 V battery (E-block type, e.g. type 6F22S or equivalent) to the contact plate.  
Insert the battery back into the compartment.  
Put the cover back.

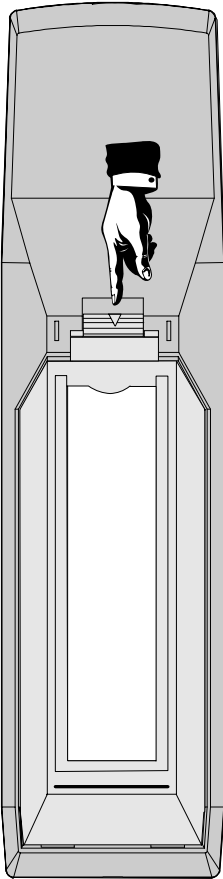

fig. 1

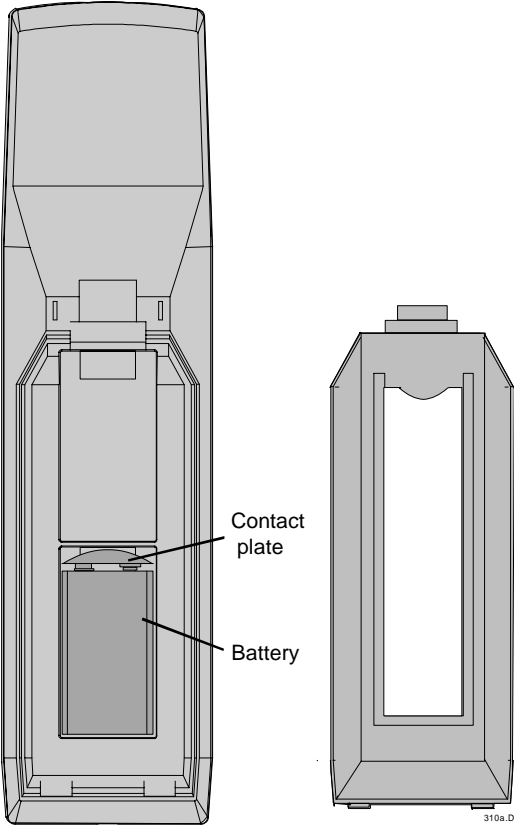
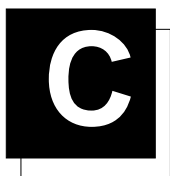

fig. 2



## LENSES

### Focusing the lens

Loosen the fastener ring of the lens by turning counter clockwise.

Focus the image by turning the lens barrel to the left or the right. Attention : Do not turn out the lens too far, otherwise it will fall out of the lens holder.

When the image is focused, secure the correct position of the lens with the fastener ring by turning this ring clockwise.

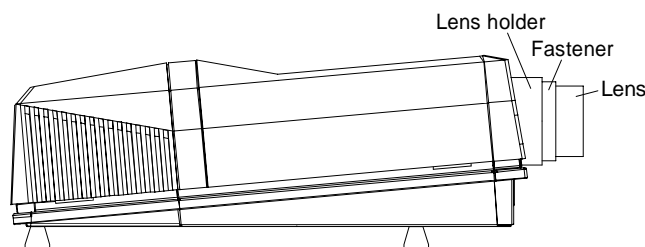

### Lens Cleaning Procedure

*Cleaning procedure for HD(1.5-3:1) lens and HD(3-5.3:1) lens.*

To minimize the possibility of damaging the optical coating or scratching exposed lens surface, we have developed recommendations for cleaning the lens. **FIRST**, we recommend you try to remove any material from the lens by blowing it off with clean, dry deionized air. **DO NOT** use any liquid to clean the lenses.

A Toraysee™ cloth is included with the lens kit.

Proceed as follows :

1. Always wipe lenses with a CLEAN Toraysee™ cloth.
2. Always wipe lenses in a single direction. Do not wipe back and forward across the lens surface as this tends to grind dirt into the coating.
3. Do not leave cleaning cloth in either an open room or lab coat pocket, as doing so can contaminate the cloth.
4. If smears occur when cleaning lenses, replace the cloth. Smears are the first indication of a dirty cloth.
5. Do not use fabric softener when washing the cleaning cloth or softener sheets when drying the cloth.
6. Do not use liquid cleaners on the cloth as doing so will contaminate the cloth.

Order number for a new Toraysee™ cloth : R379058.

Other lenses can also be cleaned safely with this Toraysee™ cloth.  
*Cleaning procedure for the other HD lens*

To minimize the possibility of damaging the optical coating or scratch-

ing exposed lens surfaces, we have developed recommendations for cleaning lenses. **FIRST**, we recommend you try to remove any material from the lens by blowing it off with deionized air or **lightly** brushing it with a soft, camel's hair brush.

Plastic lens with multilayer coatings & all glass lens elements.

1. **DO NOT** spray any type of fluid directly on the lens surface.
2. **DO NOT** use any dry material to clean the surface (dry rag, tissue, etc.)
3. Use a commercial liquid window cleaner. **DO NOT use an aerosol.** Other cleaning agents, such as laboratory-grade acetone or a 70-30 mixture of ethyl ether and ethyl alcohol may also be used. If you are not sure of the cleaning agent, experiment with a small area of the lens first.
4. Use a soft cotton cloth (cotton diapers laundered several times to remove sizing) or any soft facial tissue (Charmin, Softweve, etc.).
5. When using window cleaner, **moisten the cloth or tissue** and lightly wipe the surface. Then lightly dry with a new tissue.
6. When using acetone or ethyl ether mixture, proceed as follows : Fold the cloth or tissue several times to form a pad. Soak the folded end of the pad in the acetone. Starting at the diameter opposite you, immediately wipe the coated lens, with very little pressure, toward you in a straight line and off the lens. Do not stop with the tissue on the lens. Wipe at a speed that is equal to the evaporation rate. This is very important to prevent streaking and spotting. Start your wiping at one side of the lens and, with successive wipes, move to the other side. Turn the pad over for each wipe, then inside out. Do not make more than one wipe per clean area of pad. Be careful of the painted edge, since acetone will soften it.

**Lenses**

This APPENDIX gives an overview of the tables and formulas for the available lenses for the projector.

The next lenses are available :

Name	length lens mm (inch)	diam. lens mm (inch)	weight kg (lbs)	order number
<b>HD(1.2:1)</b>	253 (9.96)	189 (7.44)	8.7 (19.2)	R9829200
<b>HD(2.2:1)</b>	235 (9.25)	137 (5.39)	7.5 (16.5)	R9829060
<b>HD(3.3:1)</b>	149 (5.87)	152 (5.98)	4.3 (9.5)	R9829075
<b>HD(4.0:1)</b>	165 (6.50)	152 (5.98)	3.5 (7.7)	R9829145
<b>HD(5:1)</b>	238 (9.37)	164 (6.46)	5.1 (11.2)	R9829180
<b>HD(7:1)</b>	373 (14.68)	196 (7.72)	12.0 (26.4)	R9829090
<b>HD(1.5-3:1)</b>	460 (18.11)	260 (10.24)	13.0 (28.7)	R9829150
<b>HD(3-5.3:1)</b>	578(22.8)	225(8.9)	15.0(33.1)	R9829190
<b>HD(0.9:1)*</b>	366(14.4)	216(8.5)	10.0(22.0)	R9829550

**Lens formulas to calculate the projector distance.**

HD(1.2:1)	Metric	$PD=1.264 \times SW + 0.126 + (0.018/SW)$	
	Inch	$PD= 1.264 \times SW + 4.961 + (27.90/SW)$	
HD(2.2:1)	Metric	$PD=2.0566 \times SW + 0.16 + (0.029/SW)$	
	Inch	$PD=2.0566 \times SW + 6.299 + (44.95/SW)$	
HD(3.3:1)	Metric	$PD=3.33 \times SW + 0.386 + (0.046/SW)$	
	Inch	$PD=3.33 \times SW + 15.19 + (71.30/SW)$	
HD(4.0:1)	Metric	$PD=4.02 \times SW + 0.50 + (0.06/SW)$	
	Inch	$PD=4.02 \times SW + 19.69 + (93/SW)$	
HD(5:1)	Metric	$PD=5 \times SW + 0.747 + (0.070/SW)$	
	Inch	$PD=5 \times SW + 29.41 + (108.5/SW)$	
HD(7:1)	Metric	$PD=6.911 \times SW + 1.414 + (0.096/SW)$	
	Inch	$PD=6.911 \times SW + 56.06 + (148.8/SW)$	
HD(1.5-3:1)	Metric	$PD_{min}=1.49 \times SW + 0.123$	
		$PD_{max}=2.983 \times SW + 0.145$	
	Inch	$PD_{min}=1.49 \times SW + 4.84$	
		$PD_{max}=2.983 \times SW + 5.71$	
HD(3-5.3:1)	Metric	$PD_{min}=3.126 \times SW - 1.08 \pm 0.2$	
		$PD_{max}=5.345 \times SW \pm 0.2$	
	Inch	$PD_{min}=3.126 \times SW - 42.52 \pm 8$	
		$PD_{max}=5.345 \times SW \pm 8$	
HD(0.9:1) *	Metric	$PD=0.83 \times SW + 0.20$	recommended screen width range 1.2 m < SW < 3.20 m 47 inch < SW < 126 inch
	Inch	$PD=0.83 \times SW + 7.874$	

\* ON-AXIS lens, requires an on-axis projector or a retrofitted kit off -> on-axis (Ord. no. R808459K)

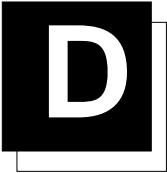

## SOURCE NUMBERS 90 - 99

### Source numbers 90 - 99

These source numbers do not correspond to physical inputs. They can only be used when the projector is equipped with a RCVDS 05 or VS05. An additional adjustment file can be created for these source numbers. This file can contain different settings. The relationship between sources 0 - 9 and 90 - 99 is shown in the diagram below.

source input 1	source number 1 source number 91	file A file A'
source input 2	source number 2 source number 92	file B file B'
source input 3	source number 3 source number 93	file C file C'
	•	
	•	
source input 9	source number 9 source number 99	file I file I'

Follow the steps below to create a second file for sources 0 to 9 :

1. Select the source between 0 and 9.
2. Select the corresponding source number between 90 and 99 with the digit keys on the RCU.
3. Enter the adjustment mode and load a corresponding file. Edit this file if necessary.
4. Save the file and exit the adjustment mode.



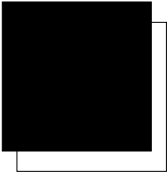

# INSERT CARD

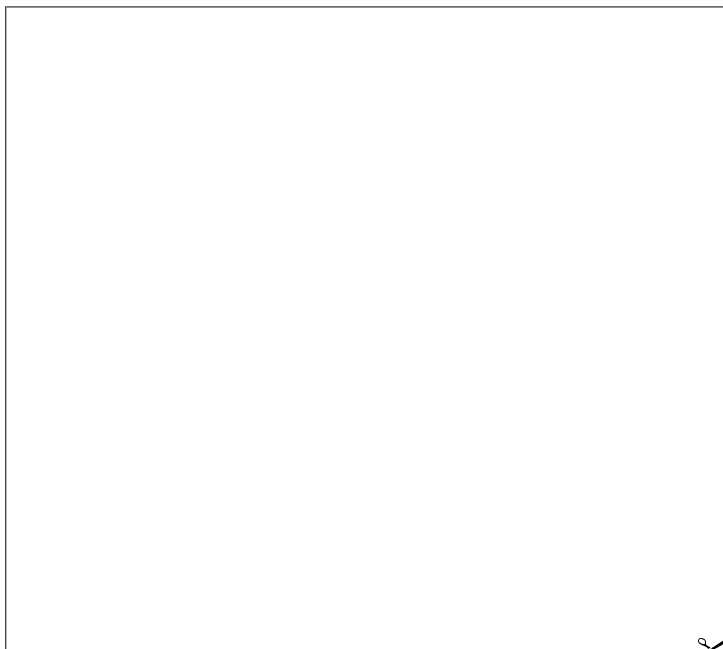

RCU	
INPUT SOURCES	
PROJECTOR	
1	
2	
3	
4	
5	
6	
7	

RCU	
INPUT SOURCES	
PROJECTOR	
1	
2	
3	
4	
5	
6	
7	

INPUT SOURCES	
RCVDS	
1	
2	
3	
5	
6	
7	
8	
9	
10	

INPUT SOURCES	
RCVDS	
1	
2	
3	
5	
6	
7	
8	
9	
10	

